

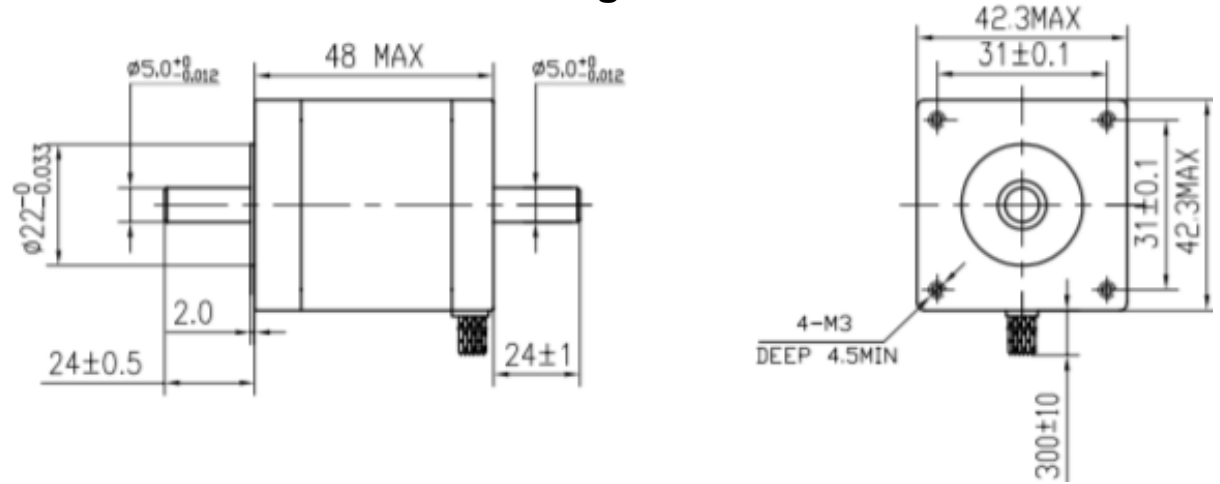

Spezifikationen / Specifications

Phase	2 Phase
Step Angle / Schrittwinkel	1.8° ± 5% / Step
Voltage / Nennspannung	3.1 V
Current / Nennstrom	2.5 A/Phase
Resistance / Widerstand	1.25 ± 10% Ω/Phase
Inductance / Induktanz	1.8± 20% mH/Phase
Holding Torque / Haltemoment	48 N.cm Min
Detent Torque / Rastmoment	2.8 N.cm Max
Insulation Class / Isolierungs Klasse	B
Lead Style / Kabel Art	AWG26 UL1007
Rotor Torque / Rotorträgheit	68 g.cm ²

Mechanische Abmessungen / Mechanical Dimensions



Verbindungen / Connections

Haltemoment Kurve / Torque Curve

17HS5425 Torque Curve

