

# TF-Luna Product Manual



TF-Luna LiDAR Module

[www.benewake.com](http://www.benewake.com)  
Benewake (Beijing) Co., Ltd.



## Product information

Model: TF-Luna

Full name: TF-Luna LiDAR Module

## Manufacturer

Company: Benewake (Beijing) Co. Ltd.

Address: No.28, Xinxu Road, Haidian District, Beijing, PRC

## Copyright

This document is protected by copyright. All rights related to it belong to Benewake (Beijing) Co. Ltd. Reproduction of all or part of this document is permitted only within the scope of copyright law. No modification, deletion, or translation of this document is permitted without the official written permission of Benewake (Beijing) Co. Ltd.

All rights reserved © Benewake (Beijing) Co. Ltd.

## Certification





## Foreword

Dear users,

Thanks you for choosing Benewake products and it's our pleasure to help you with any technical question.

To have a better experience, please read this manual carefully. We try to contain all common problems and hope you find the deployment and installation easy and fun.

This manual will guide you through the installation and operation process and show you some solution of common problems. It is still possible that you encounter some difficulties that are not included, please check our support service (support@benewake.com) and don't hesitate to contact our support consultants or leave a message on our feedback page of our official website:  
<http://benewake.com/en/mfeedback.html>

We hope you enjoy our product and join our community!

We are Benewake! Our goal is to make the best "Robotic Eyes" in the world!



## Catalog

|      |  |    |
|------|--|----|
| 1    | Revisions .....                                      | 7  |
| 2    | Cautions .....                                       | 7  |
| 2.1  | About document.....                                  | 7  |
| 2.2  | About product .....                                  | 8  |
| 2.3  | Common errors and other notes.....                   | 8  |
| 3    | Principle description and key parameters.....        | 8  |
| 3.1  | Ranging Principle.....                               | 8  |
| 3.2  | Basic Characteristic Parameters .....                | 9  |
| 3.3  | Repeatability .....                                  | 9  |
| 3.4  | Ranging Characteristics.....                         | 10 |
| 4    | Appearance and Structure.....                        | 11 |
| 4.1  | Appearance .....                                     | 11 |
| 5    | Electrical Characteristics .....                     | 11 |
| 6    | Functional Descriptions and Configuration.....       | 12 |
| 6.1  | Description about Line Sequence and Connection ..... | 12 |
| 6.2  | Serial Port Communication Protocol .....             | 12 |
| 6.3  | I2C Communication.....                               | 13 |
| 6.4  | Basic Data Output .....                              | 14 |
| 6.5  | Continuous Ranging Mode.....                         | 15 |
| 6.6  | Trigger Mode .....                                   | 15 |
| 6.7  | On/off Mode .....                                    | 15 |
| 6.8  | Amp Threshold .....                                  | 16 |
| 6.9  | Distance Limit .....                                 | 16 |
| 6.10 | Power Saving Mode.....                               | 16 |



|  |  |    |
|--|--|----|
| 6.11   | Ultra-low Power Mode .....   | 17 |
| 6.11.1   | Ultra-low Power Mode with Serial Port Communication .....          | 18 |
| 6.11.2   | Ultra-low Power Mode with I2C communication.....                   | 19 |
| 6.11.3   | Caveats.....   | 20 |
| 6.12   | Single Frequency Mode .....  | 20 |
| 6.13   | Additional notes .....   | 20 |
| 7  | Quick Test Guide.....  | 21 |
| 7.1  | Required tools for testing .....                                   | 21 |
| 7.2  | Steps.....   | 21 |
| 8  | Firmware upgrade .....   | 23 |
| Appendix I Serial port output format.....      |  | 24 |
| 1.   | 9-byte/cm (Default).....   | 24 |
| 2.   | PIX .....  | 24 |
| 3.   | 9-byte/mm.....   | 24 |
| 4.   | 32-byte with timestamp.....  | 24 |
| 5.   | ID-0 output .....  | 24 |
| 6.   | 8-byte/cm.....   | 24 |
| 7.   | Output with Device ID .....  | 25 |
| Appendix II Serial communication protocol..... |  | 26 |
| 1.   | Version information ID_GET_VERSION=0x01.....                       | 26 |
| 2.   | System software restore ID_SOFT_RESET=0x02.....                    | 26 |
| 3.   | Output frequency ID_SAMPLE_FREQ=0x03.....                          | 26 |
| 4.   | Trigger mode ID_SAMPLE_TRIG=0x04.....                              | 27 |
| 5.   | Output format setting ID_OUTPUT_FORMAT=0x05 .....                  | 27 |
| 6.   | Baud rate setting ID_BAUD_RATE=0x06 .....                          | 27 |
| 7.   | Enable/disable output ID_OUTPUT_EN=0x07 .....                      | 28 |
| 8.   | Enable/disable checksum comparison ID_FRAME_CHECKSUM_EN=0x08 ..... | 28 |



|     |   |    |
|-----|---|----|
| 9.  | I2C slave machine address configuration ID_I2C_SLAVE_ADDR=0x0B.....         | 28 |
| 10. | Restore default setting ID_RESTORE_DEFAULT=0x10 .....                       | 29 |
| 11. | Save current setting ID_SAVE_SETTINGS=0x11.....                             | 29 |
| 12. | Output product bar code ID_READ_MANU_BIN=0x12 .....                         | 29 |
| 13. | Get full-length version number ID_GET_FULL_VERSION=0x14 .....               | 30 |
| 14. | Amp threshold setting ID_AMP_THRESHOLD=0x22 .....                           | 30 |
| 15. | Switch between Single Frequency and Dual Frequency ID_DEALIAS_EN =0x29..... | 30 |
| 16. | Timestamp synchronization ID_TIMESTAMP_SYNC =0x31 .....                     | 31 |
| 17. | Enable/disable Power saving mode (ECO) ID_LOW_CONSUMPTION=0x35 .....        | 31 |
| 18. | Filter Setup ID_FILTER_BIT_MAP=0x39 .....                                   | 31 |
| 19. | Distance limit setting ID_DIST_LIMIT=0x3A.....                              | 32 |
| 20. | Enable/disable on-off mode ID_ON_OFF_MODE=0x3B .....                        | 32 |
| 21. | Read config by id ID_GET_CONFIG_PARA=0x3F .....                             | 32 |
| 22. | Ultra-low Power Mode ID_ULTRA_LOW_POWER_MODE=0x58 .....                     | 33 |
| 23. | Frequency Calibration ID_FREQ_CNT_CALIB=0x59 .....                          | 33 |
|     | Appendix III I2C register table.....  | 34 |





## 1 Revisions

| Version No. | History  | Date      |
|-------------|--|-----------|
| A00         | Original   | 2020.1.15 |
| A03         | <ol style="list-style-type: none"><li>1. Old serial port formats are removed.</li><li>2. Module size and related pictures are updated.</li><li>3. More description of function.</li><li>4. I2C interface is now available.</li><li>5. Power supply voltage up to 3.7V-5.2V is now supported.</li></ol>   | 2020.3.15 |
| A05         | <ol style="list-style-type: none"><li>1. Removed “Enable/disable low sample rate mode ID_LOW_SAMPLE_RATE=0x3E”.</li><li>2. Changed the definition of I2C register 0x25: 0x00 – LiDAR off, 0x01 – LiDAR on.</li><li>3. Changed the description of I2C register. Users should make sure that firmware version is above V1.0.7 when using I2C communication.</li><li>4. Added the description on Amp with respect to ambient light overexposure.</li><li>5. Added Ultra-low Power Mode.</li><li>6. For I2C register 0x2E-0X31, changed the units of distance limit from centimeter to millimeter.</li><li>7. Added description on the Single Frequency Mode.</li><li>8. Added filter setup commands.</li><li>9. Added device ID into the output format.</li></ol> | 2020.7.23 |

## 2 Cautions

### 2.1 About document

- This manual provides all essential information you may need during the usage of this product.
- Please read this manual carefully before using this product and make sure that you fully understand the contents of the manual.



## 2.2 About product

- The product can only be maintained and repaired by qualified professionals, and only original spare parts are permitted to use for performance and safety reasons.
- This product DOES NOT have polarity and over-voltage protection at all. Please wire and supply power according to the instructions.
- The working temperature of the product is from  $-10^{\circ}\text{C}$  to  $60^{\circ}\text{C}$ , please do not use it outside this temperature range to avoid risk and damage.
- The storage temperature of the product is from  $-20^{\circ}\text{C}$  to  $75^{\circ}\text{C}$ , please do not store it outside this temperature range to avoid risk and damage.
- For safety and performance, please DO NOT open the product casing or remove the IR-pass filter.

## 2.3 Common errors and other notes

- Detecting object with high reflectivity, such as mirrors, smooth floor tiles, and calm milk liquid.
- Blocking the product with any transparent objects, such as water or glasses.
- The product's lens may be covered by dusts or dirt which may affect results, so please keep the lens clean.
- The exposed circuit board is electrostatic sensitive. Please do not touch the circuit board of the product barehanded. Please use ESD wrist strap or antistatic gloves to ground yourself if any operation is necessary; Otherwise, the product may be damaged by static electricity.

# 3 Principle description and key parameters

## 3.1 Ranging Principle

TF-Luna is using Time of Flight (ToF) principle to measure the distance and it periodically emits near infrared modulated waves. TF-Luna calculates the time by measuring the phase difference between the original wave and the reflection wave and uses that time to get relative distance, as shown in *Figure 1*.



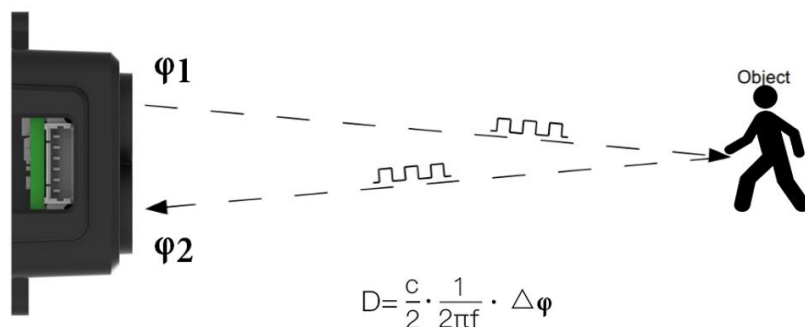

Figure 1 Schematics of ToF Principle

## 3.2 Basic Characteristic Parameters

Table 1 Parameters specification of TF-Luna

| Description      | Parameter value                      |
|------------------|--------------------------------------|
| Operating range  | 0.2m~8m <sup>①</sup>                 |
| Accuracy         | ±6cm@ (0.2-3m)                       |
|                  | ±2%@ (3m-8m)                         |
| Measurement unit | cm (Default)                         |
| Range resolution | 1cm                                  |
| FoV              | 2° <sup>②</sup>                      |
| Frame rate       | 1~250 Hz ( adjustable ) <sup>③</sup> |

① Operating range is measured indoor based on a standard whiteboard with reflectivity 90%.

② This is theoretical value, real value may be different.

③ 100 Hz is default and only any factor (500/n, n can be any integer in [2, 500]) of 500Hz is available.

## 3.3 Repeatability

TF-Luna's ranging accuracy is positively correlated with the strength value (amp) and negatively correlated with the output frame rate (frequency). The tables below show the standard deviation (STD) using 100Hz output rate. These values are for reference only; various testing environments may give different results.

Table 2 STD Amp correlation

| Amp | 100 | 200 | 400 | 1000 | ≥2000 |
|-----|-----|-----|-----|------|-------|
| STD | 3cm | 3cm | 2cm | 1cm  | 0.5cm |



Table 3 STD Dist correlation with 90% diffuse reflectance object

| Dist | 200cm | 400cm | 600cm | 800cm |
|------|-------|-------|-------|-------|
| Std  | 0.5cm | 1cm   | 1.5cm | 2cm   |

### 3.4 Ranging Characteristics

TF-Luna minimizes the impact of external environment on ranging performance by optimizing light path and algorithm.

TF-Luna's ranging blind zone is 20 cm. Any distance output less than 20 cm is unreliable. The operating range of black and white targets is different:

The operating range of TF-Luna detecting black target with 10% reflectivity is 0.2-2.5m; the operating range of TF-Luna detecting white target with 90% reflectivity is 0.2-8m.

The ranging data is reliable only if the reflection surface fully covers the light spot, so the diameter of the object must at least the same as the diameter of the light spot, and that diameter depends on FoV of TF-Luna. The minimum diameter of the object surface can be determined by the following formula:

$$d = 2 * D * \tan\beta$$

In the formula, d represents the minimum diameter, D is the distance of the object, and  $\beta$  is the half FoV of TF-Luna. Common values are shown in *Table 4* for your convenience:

Table 4 Distance and minimum diameter

| Distance (D)         | 1m    | 2m  | 3m     | 4m   | 5m     | 6m   | 7m     | 8m   |
|----------------------|-------|-----|--------|------|--------|------|--------|------|
| Minimum diameter (d) | 3.5cm | 7cm | 10.5cm | 14cm | 17.5cm | 21cm | 24.5cm | 28cm |

If the light spot reaches two objects with different distances as Figure 2, the output distance value (Dist) will be abnormal, which may cause error for high-accuracy applications. Please try to avoid this situation for better accuracy and performance.



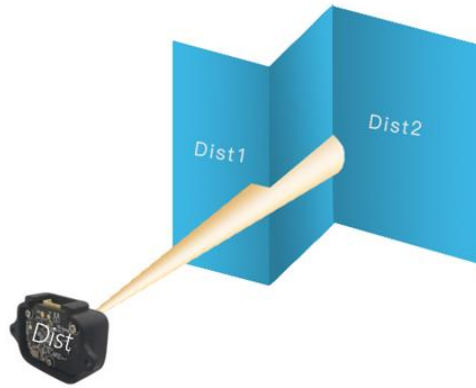

Figure 2 Detecting two objects at different location

## 4 Appearance and Structure

### 4.1 Appearance

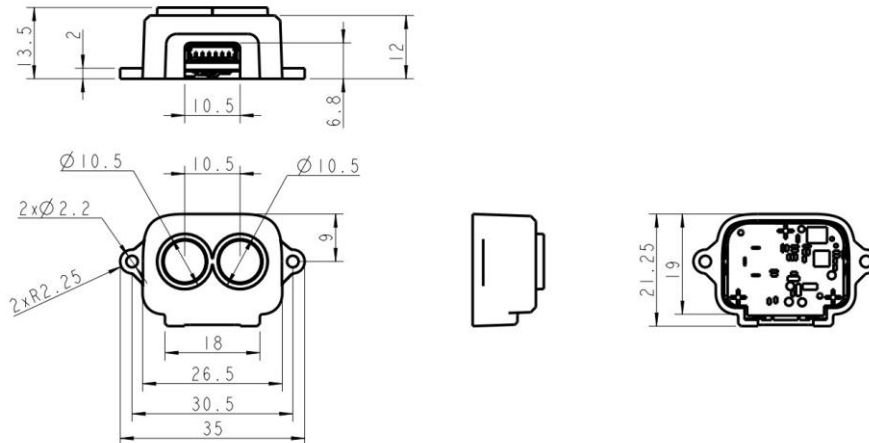

Figure 3 TF-Luna appearance and size drawing

## 5 Electrical Characteristics

Table 5 Major Electrical Parameters of TF-Luna

| Description                | Value range         |
|----------------------------|---------------------|
| Power supply voltage       | 3.7V-5.2V           |
| Average current            | $\leq 70\text{mA}$  |
| Peak current               | 150mA               |
| Power consumption          | $\leq 350\text{mW}$ |
| Communication signal level | LVTTTL (3.3V)       |

This product has no overvoltage nor polarity protection, so please make sure that the product is well connected, and the power supply voltage is inside the given range.



## 6 Functional Descriptions and Configuration

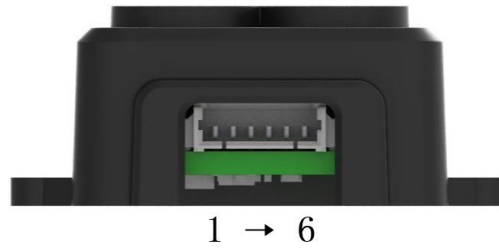

Figure 4 TF-Luna's pin numbers

### 6.1 Description about Line Sequence and Connection

Table 6 The Function and Connection Description of Each Pin

| No. | Function            | Description  |
|-----|---------------------|--|
| 1   | +5V                 | Power supply   |
| 2   | RXD/SDA             | Receiving/Data   |
| 3   | TXD/SCL             | Transmitting/Clock   |
| 4   | GND                 | Ground   |
| 5   | Configuration Input | Ground: I2C mode<br>Disconnected/3.3V: Serial port Communications mode |
| 6   | Multiplexing output | On/off mode: Output<br>I2C mode: Data ready signal                     |

### 6.2 Serial Port Communication Protocol

Serial port communication starts when pin 5 is disconnected or connected to 3.3v. It will set TF-Luna receiving RXD on pin 2 and sending TXD on pin 3. The serial port communication protocol is defined as follows: 8 data bits, 1 stop bit with no parity check and default baud rate of 115200 bps.

Serial port communication protocol data byte format:

| byte        | 0          | 1   | 2  | 3~Len-2 | Len-1    |
|-------------|------------|-----|----|---------|----------|
| Description | Head(0x5A) | Len | ID | Payload | Checksum |

Head: Fixed 0x5A.

Len: The length of bytes from the head byte to check-sum at the end, and it has to be in between 4 to 255.



ID: Indicates how to parse the payload data.

Payload: Payload data segment, optional.

Checksum: The lower 8 bytes of the sum from Head to Payload.

Please check **Appendix II Serial communication protocol** for more information.

**Note:** TF-Luna does not enable checksum check for sending data frames by default, that is, the Checksum at the end of the sending frame can be filled with any value.. Thus, **ANY** value is acceptable on the Checksum byte, **unless** checking of those bytes is required. Please check “**Enable/disable checksum comparison ID\_FRAME\_CHECKSUM\_EN=0x08**” in **Appendix II Serial communication protocol** to enable the feature.

The instruction makes change immediately after sending, but the current setting is not saved and will be lost after reboot. User must use “**Save current setting ID\_SAVE\_SETTINGS=0x11**” to save the change. The full save-current-setting hexadecimal sequence is 5A 04 11 00 in this case.

### 6.3 I2C Communication

When pin 5 is connected to ground, TF-Luna enters I2C mode, then its pin 2 is used as SDA data and pin 3 is the SCL clock sending data. TF-Luna supports up to 400kps clock speed as slave machine and its default address is 0x10. For more information about I2C register table refer to **Appendix III I2C register table**.

Note: In this document, the address of I2C slave device is a 7-bit value with value range [0x08, 0x77] ([0, 119] in decimal). For the first byte after I2C releases a start signal, the 7-bit address should be shifted leftward for one bit (i.e. multiplied with 2), and then filled with the read-write sign on the lowest bit. For TF-Luna, the default address of slave device is 0x10, the address for write operations is 0x20, and the address for read operations is 0x21.

Write register timing:

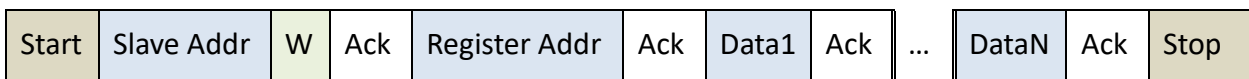

Read register timing:

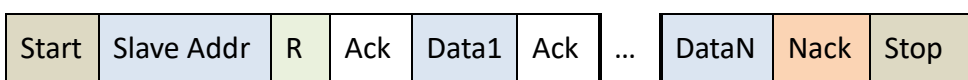
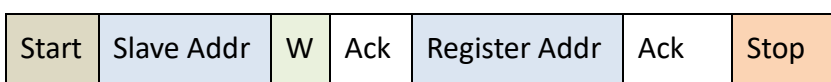



Note that in the read register sequence, the host can directly generate the second Start signal without generating the first Stop signal. The last Nack can also be an Ack signal.

In the continuous ranging mode, the host must monitor pin 6 for synchronous signal and initiate the read data operation in time. Otherwise, it may cause an error by reading and updating the data register at the same time. In multi-machine bus mode, use command to trigger reading is strongly recommended.

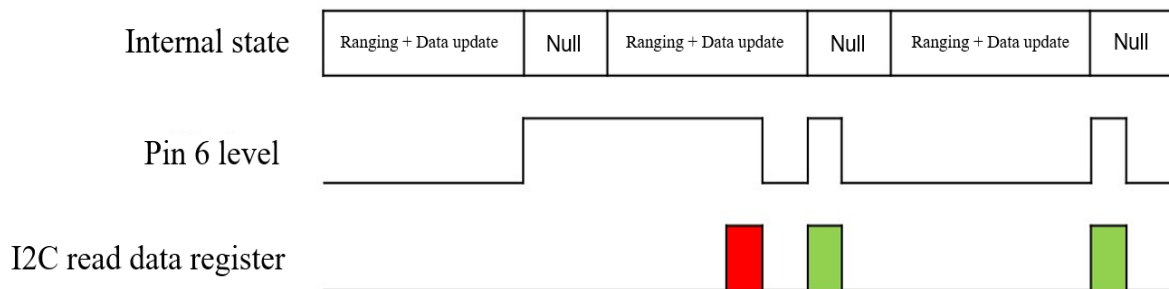

Figure 5 Timing of reading data register in I2C mode

Pin 6 is normal low level and it switches to high as soon as the data is updated. It switches to low level only if a read operation on any register is done. Therefore, I2C host must read the register when receive a high level on pin 6 in the continuous ranging mode. As the figure has shown above, the first result in red is unreliable and the rest two in green are accurate.

After a write operation on the I2C register, it takes TF-Luna some time to process. If users need to read the value from the register for validation purposes, we recommend waiting for 100ms after the write operation, prior to the next read operation.

## 6.4 Basic Data Output

TF-Luna normally provides these data below:

- Distance (**Dist**): Default in centimeters.
- Signal strength (**Amp**): Distance value is unreliable when receiving signal is overexposed (Amp = 0xFFFF) or too low (Amp < 100). Normally, Amp value should not be above 30000. When Amp is above 32768, it indicates that TF-Luna has detected an ambient light overexposure, for instance, when it faces the sun in outside.
- Chip Temperature (**Temp**): Celsius degree = Temp/8 - 256°C

TF-Luna supports various serial format, please check **Appendix I Serial port output format** for more information, and the default setting is 9-bytes/centimeter. Format setting is in “**Output format**”



setting `ID_OUTPUT_FORMAT=0x05`” section.

## 6.5 Continuous Ranging Mode

TF-Luna will keep tracking the distance 500 times per second, but as the customized output frequency is lower, the output may take the average. For instance, if the output frequency is 100Hz as default, then the output values are the average (arithmetic mean) of 5 previous range data. Therefore, lower output frequency gives less time of the averaging process as well as less fluctuation of the output. The highest output frequency that TF-Luna supports is 250Hz ( $\text{output\_frequency} \leq 250\text{Hz}$ ), and it must be  $500/n$  Hz (where  $n$  is an integer that is in the range  $[2, 500]$ ). Thus, all supported values of output frequency are: 250Hz, 166Hz, 125Hz, 100Hz, ..., 2Hz, 1Hz. User can change the output frequency using **“Output frequency ID\_SAMPLE\_FREQ=0x03”**.

## 6.6 Trigger Mode

TF-Luna enters trigger mode if the output frequency is set to 0 with **“Output frequency ID\_SAMPLE\_FREQ=0x03”**. In this mode, TF-Luna stops measuring and outputting unless it is triggered by **“Trigger mode ID\_SAMPLE\_TRIG=0x04”** — in other words, TF-Luna measures and output once as soon as it receives the hexadecimal byte string 5A 04 04 00.

## 6.7 On/off Mode

On/off mode is designed from those users who only need to detect the existence of an object. TF-Luna can start this mode using **“Enable/disable on-off mode ID\_ON\_OFF\_MODE=0x3B”** and then shows result through pin 6. Figure 6 below shows how the mode works when a high level is set to represent an object is detected.

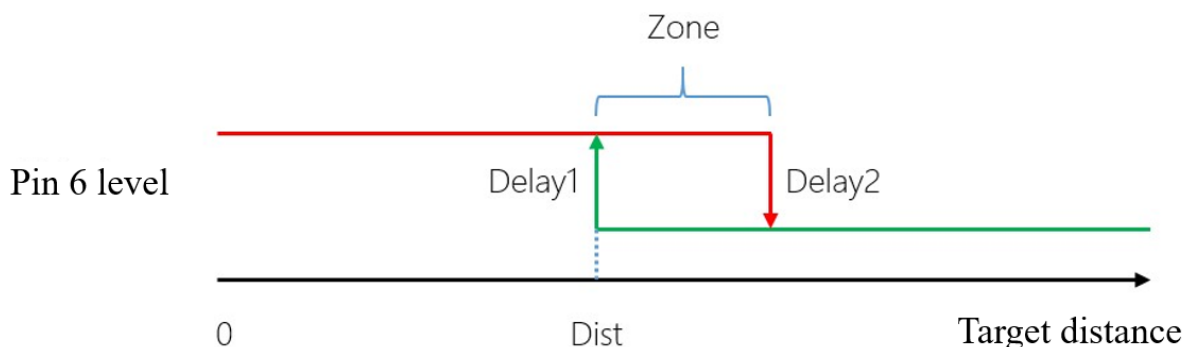

Figure 6 On/off mode that high level means closer

Zone value: If an object is detected closer than  $\text{Dist}$ , then Pin 6 outputs high-level, but only if an object is detected farther than  $\text{Dist} + \text{Zone}$ , then Pin 6 outputs low-level. When zone is set to 0, pin 6 may output up and down cause by fluctuation of the measuring when the real distance happens to be



the same as Dist. That is why a proper zone value is needed to help avoid this situation by having a hysteretic interval.

Delay is also supported to avoid inaccurate jumping output. Pin 6 changes its output depends on the Dist value condition and the time it lasts. Delay1(ms) and Delay2(ms) determine how long that approaching changes and leaving changes should wait after Dist value is already over the line.

**Note:** Since the Dist value is set to 0 under factory setting when no object is detected and Amp is too low, then pin 6 may have false output in the on/off mode. Please follow the instructions in **6.8 Amp** to set the over-threshold value greater than Dist + Zone to avoid false output.

## 6.8 Amp Threshold

The distance calculation may get false result if the Amp value is too low, so TF-Luna set the Dist value to dummy\_dist(Default 0) when Amp is lower than amp\_threshold (Default 100). If a user needs to change the Amp threshold value, please follow instructions in “**Amp threshold setting ID\_AMP\_THRESHOLD=0x22**”. Note that the final Amp threshold in TF-Luna is 10 times the value you send to it.

## 6.9 Distance Limit

TF-Luna has a default maximum and minimum distance output: [min, max] = [0cm, 900cm].

User can change the output limits using “**Distance limit setting ID\_DIST\_LIMIT=0x3A**”.

**Note:** Any distance value lower than 20cm or greater than 800cm may be unreliable.

## 6.10 Power Saving Mode

The power consumption of TF-Luna is determined by two factors: the light source driving current and the light-emitting duty cycle.

TF-Luna adjusts the driving current of the light source adaptively to achieve the purpose of large dynamic range adapting to different distances and different reflectivity targets. When the signal strength is too high, it will automatically switch to low gear current work. On the contrary, when the signal strength is too low, it will automatically switch to high gear current work. The higher the current gear is, the greater the power consumption will be.

Refer to “**6.5 Continuous Ranging**”. In continuous ranging mode, TF-Luna always emits light with the highest duty cycle, which does not change with the output frequency. Therefore, when TF-Luna is in continuous working mode and the current gear is at the highest gear, the power consumption is the largest. When the power is supplied with 5V, the power consumption is about 350mW.





The user can change TF-Luna's luminous duty cycle in two ways. The first is to use the command trigger mode. TF-Luna does not emit light when it does not receive a ranging command. At this time, the power consumption is about 42.5mW (5V power supply). The actual power consumption is determined by the frequency of the command trigger. Another way is to enable the low power consumption mode provided by TF-Luna. The internal working mechanism of this mode is the same as the command trigger mode, except that the trigger signal is automatically generated internally by TF-Luna. The user can set the TF-Luna to enter the low-power mode through the "**Enable/disable Power saving mode (ECO) ID\_LOW\_CONSUMPTION=0x35**" instruction.

To ensure the internal working sequence of TF-Luna, the maximum output frequency of low power consumption mode is 10Hz. The following table lists the reference values of the average power consumption at different operating frequencies in the low power mode when the power supply is 5V. The actual power consumption may be affected by the ambient temperature or the supply voltage, and may differ from the reference value.

| Power saving frequency | Avg current(mA) | Avg power (mW) |
|------------------------|-----------------|----------------|
| 1Hz                    | 8.85            | 44.25          |
| 2Hz                    | 9.2             | 46             |
| 3Hz                    | 9.55            | 47.75          |
| 4Hz                    | 9.9             | 49.5           |
| 5Hz                    | 10.25           | 51.25          |
| 6Hz                    | 10.6            | 53             |
| 7Hz                    | 10.95           | 54.75          |
| 8Hz                    | 11.3            | 56.5           |
| 9Hz                    | 11.65           | 58.25          |
| 10Hz                   | 12              | 60             |

### 6.11 Ultra-low Power Mode

In order to further reduce power consumption, TF-Luna offers an Ultra-low Power Mode. In this mode, MCU enters sleep mode, and the standby power consumption of TF-Luna is about 1.5mW at this time. However, when MCU sleeps, it is not able to automatically awake as Low Power Mode is activated. Therefore, we need to change the voltage of Pin 2 to wake it up.





### 6.11.1 Ultra-low Power Mode with Serial Port Communication

#### (1) Turn on Ultra-low Power Mode

The command **“Ultra-low Power Mode ID\_ ULTRA\_LOW\_POWER\_MODE=0x58”** is used to turn on Ultra-low Power Mode. TF-Luna will stop serial port outputting data once the command is delivered. However, it will not enter the mode immediately. Users should send **“Save current setting ID\_SAVE\_SETTINGS=0x11”** to save current settings and then send **“System software restore ID\_SOFT\_RESET=0x02”** to reset system. Later on, TF-Luna will enter the Ultra-low Power Mode. Since the settings have been saved, TF-Luna will enter directly into this mode on next boot-up.

#### (2) Bring up Range-finding

Users can wake up TF-Luna and make it perform range-finding once by sending a random byte to the serial port. TF-Luna will send back the range-finding result in a specific format, and then enter Ultra-low Power Mode once again. The following graph shows the case in which the baud rate is 115200 with 9-byte output format. The awakening lasts about 8.5ms.

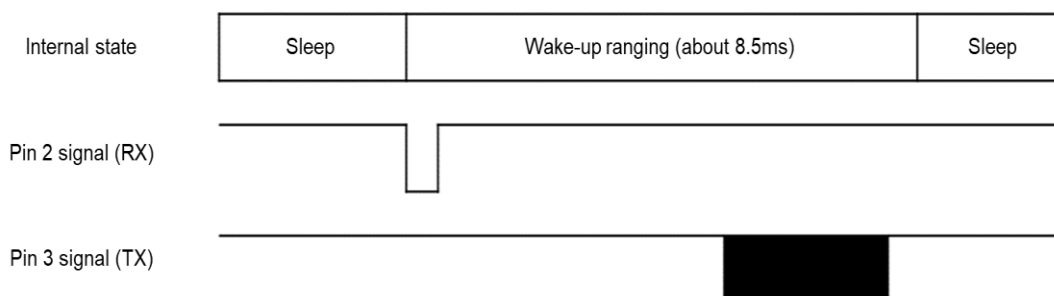

Figure 7 Time sequence of Ultra-low Power Mode with serial port communication

#### (3) Turn off Ultra-low Power Mode

Users cannot exit the Ultra-low Power Mode directly, because the serial port communication module is disabled. TF-Luna can only receive serial port commands during short intervals when it is awake. Therefore, users need to continuously send the command **“Ultra-low Power Mode ID\_ ULTRA\_LOW\_POWER\_MODE=0x58”** to disable the Ultra-low Power Mode until TF-Luna responds. After that, users should send **“Save current setting ID\_SAVE\_SETTINGS=0x11”** command to save current settings.

#### (4) Estimation of Power Consumption



TF-Luna consumes 1.5mW during sleep and on average 260mW during awakening. The awakening will last about 8.5ms. Based on the information, it consumes on average 3.7mW if we wake it up every second and on average 1.72mW if we wake it up every ten seconds.

### 6.11.2 Ultra-low Power Mode with I2C communication

#### (1) Turn on Ultra-low Power Mode

In order to turn on and save Ultra-low Power Mode, users need to write three consecutive bytes [0x01, 0x01, 0x02] to the address 0x1F.

#### (2) Bring up Range-finding

Users can attempt reading any one of valid or invalid register addresses (which will not make us receive ACK from the slave device). In this way, TF-Luna will detect the change of voltage on Pin 2 and thus it will be awoken. TF-Luna will perform range-finding once upon each awakening, and update the result on the register. It will not fall back to sleep mode until the user performs a read-register operation.

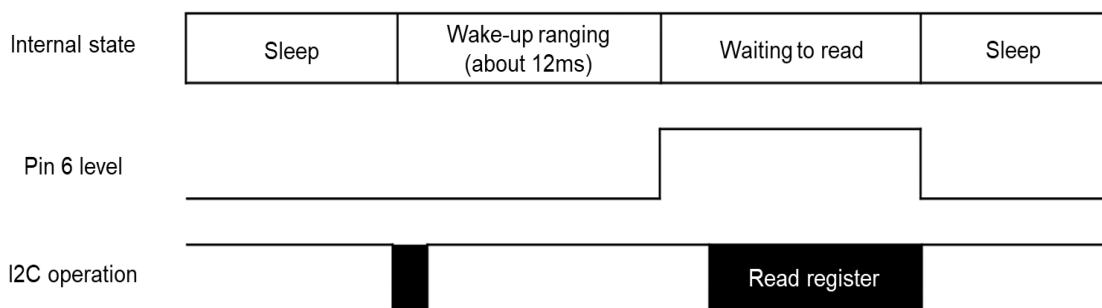

Figure 8 Time sequence of Ultra-low Power Mode with I2C communication

#### (3) Turn off Ultra-low Power Mode

Reading the register will make TF-Luna enter sleep mode once again, therefore, in order to turn off the Ultra-low Power Mode, users need to write three consecutive bytes [0x00, 0x01, 0x02] to the address 0x1F after the awakening. It should be done no sooner than 6ms after the awakening).

#### (4) Estimation of Power Consumption

TF-Luna consumes 1.5mW during sleep and on average 200mW during awakening.



Range-finding in an awakening period takes about 12ms, and awaiting users' read-operation consumes about 42.2mW. Assuming it waits for 5ms, based on the information, it consumes on average 4.1mW if we wake it up every one second, and on average 1.76mW if we wake it up every ten seconds.

### 6.11.3 Caveats

Users should not send any setup command in the Ultra-low Power Mode, because MCU will be in sleep so that it may not respond to users' command. In Ultra-low Power Mode, it is only allowed to bring up range-finding, or to turn off the mode. All other operations should be performed after the mode is turned off.

## 6.12 Single Frequency Mode

TF-Luna obtains distance measurement from phase shift of the sinusoidal modulated laser light. The model is subjected to the "periodic distance" problem. The periodic distance for TF-Luna is 15 meters, when working in Single Frequency Mode. However, when the distance is beyond 15 meters, the measured value starts from zero again. Assuming there is a highly reflective object at 16 meters; TF-Luna may mistake it as at 1 meter. In order to extend the periodic distance, TF-Luna sets the default work mode to Dual Frequency Mode. The periodic distance in such a mode is over 65 meters, far wider than the sensor's measuring range. In this way, the "overshoot" problem is addressed.

However, in Dual Frequency Mode, the range-finding algorithm requires higher stability on sensor data. When the signal is weak (AMP lower than 100), the low data stability produces errors in the range algorithm, and thus yields anomalies in output range values. The error can reach tens of meters. In some application scenarios, the target reflection rate is low so that AMPs lower than 100 are needed. In this case, users can set TF-Luna to Single Frequency Mode. In Single Frequency Mode, when AMP is lower than 100, the stability of range data is low. Even so, it is not allowed to have significant anomalies on data values. Meanwhile, users should make sure their application scenarios are not subjected to the overshoot problems.







## 6.13 Additional notes

Please check **Appendix II Serial communication protocol** for more options, such as version ID report, system software restore, baud rate configuration, etc.



## 7 Quick Test Guide

### 7.1 Required tools for testing

|   |   |   |  |   |   |
|---|---|---|--|---|---|
|  |  |  |  |  |  |
| TF-Luna   | Data cable  | TTL to USB convertor  | USB cable  | PC  | PC software   |

### 7.2 Steps

- ① Download and install the latest test software

Please visit our official website ([en.benewake.com](http://en.benewake.com)) and download the test software of TF-Luna.

Note: Please turn off any anti-virus software before uncompressing the PC software. Some anti-virus software may regard the '.exe' file as virus. Also, released versions are only running on windows systems currently.

- ② Connecting hardware and cables



Figure 9 Schematic Diagram of Correct Connection

Please connect TF-Luna, TTL-USB converter, and USB cable properly as shown in Figure 9. Please check if there is any loose connection, and then plug the USB cable into your PC.

- ③ Open your test software and check data output

Open the PC software and select “①TF-Luna” and select automatically recognized occupied serial port (in this case “② COM9”) as shown in Figure 10.

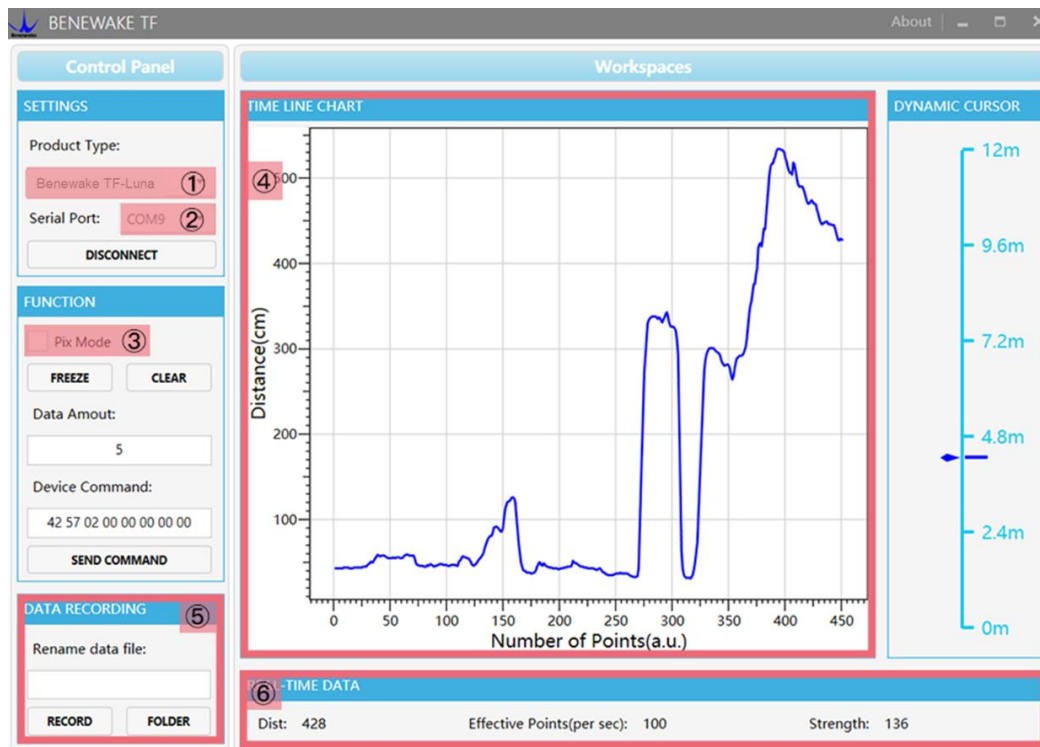

Figure 10 PC software Interface and Display

Now click the “CONNECT” button, and a continuous images of the output data will be displayed in area “④ TIME LINE CHART” on the right if everything is connected successfully. The real-time data of the Current measure distance (Dist), effective data points per second (Effective Points) and signal strength (Strength) will be displayed in area “⑥ REAL TIME DATA” below as well.

Notes:

- If nothing is displayed in area “④TIME LINE CHART”, please check the wire connection and sequence. A red LED indicator inside the transmitting lens at front will light up when TF-Luna is power-on.
- Please select “③Pix Mode” before switching TF-Luna’s outputs to Pixhawk format to avoid abnormal data display in the “④TIME LINE CHART” area. Note that selecting Pix Mode will automatically set the unit of distance to meters.
- Since TF-Luna does not pass unit information and the software always uses centimeters as distance unit, the distance unit displayed in the chart remains the same as centimeter even if TF-Luna output in millimeter. For instance, suppose the actual measurement is one meter and the distance value from TF-Luna is 1000 mm, then the value read by the PC software is 1000. Thus, the software will display 1000 with unit cm.



## 8 Firmware upgrade

TF-Luna allows upgrading firmware remotely when current firmware no longer supports users' new requirements. Please contact us for the additional remote upgrading software if any relevant firmware upgrades are available on Benewake official website.

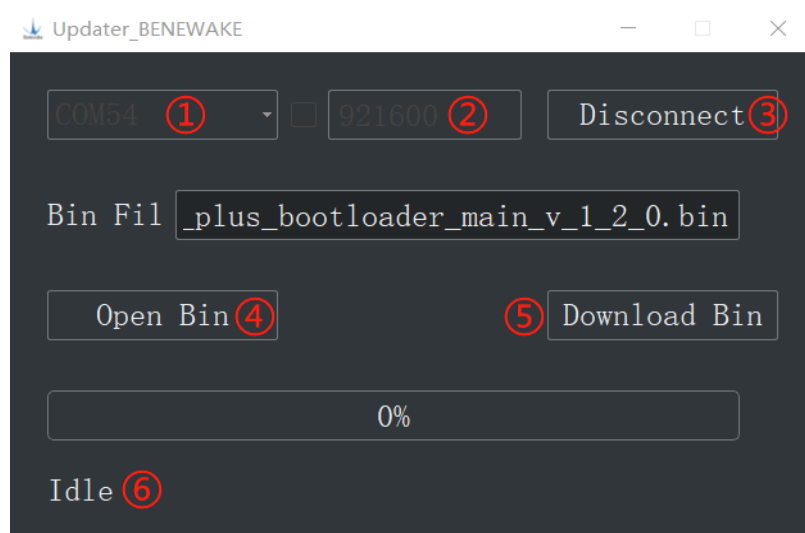

Figure 11 Firmware Upgrade PC software of TF-Luna

The tools for an upgrade are mostly the same as those in the Quick Test Guide, including a TTL-USB convertor to connect TF-Luna with PC.

Open the Updater.exe after connecting TF-Luna to your PC, and then select the correct port and baud rate, “①COM8” and “② 115200” in this case. Click “④ Open Bin” to choose the updating firmware, then the file directory will be displayed in the textbox above. Finally, click “⑤ Download Bin” to start upgrading and the upgrading information will show up in “⑥”.

**Note:** The full directory of the firmware files must use English letters only.





## Appendix I Serial port output format

### 1. 9-byte/cm (Default)

This format is supported for any firmware after Ver. 0.0.5

| Byte        | 0    | 1    | 2      | 3      | 4     | 5     | 6      | 7      | 8         |
|-------------|------|------|--------|--------|-------|-------|--------|--------|-----------|
| Description | 0x59 | 0x59 | Dist_L | Dist_H | Amp_L | Amp_H | Temp_L | Temp_H | Check_sum |

Dist: cm

Amp: Signal strength indicator. Dist value is unreliable when Amp < 100 or Amp = 65535 (Overexposure)

Temp: Celsius temperature = Temp / 8 - 256°C

### 2. PIX

This format is supported for any firmware after Ver. 0.0.5

“X.YZ\r\n” is a sample ASCII string and only keep two significant digits in meter where “X.YZ” is the result.

### 3. 9-byte/mm

This format is supported for any firmware after Ver. 0.0.5

| byte        | 0    | 1    | 2      | 3      | 4     | 5     | 6      | 7      | 8         |
|-------------|------|------|--------|--------|-------|-------|--------|--------|-----------|
| Description | 0x59 | 0x59 | Dist_L | Dist_H | Amp_L | Amp_H | Temp_L | Temp_H | Check_sum |

Dist: mm

Amp: Signal strength indicator. Dist value is unreliable when Amp < 100 or Amp = 65535 (Overexposure)

Temp: Celsius temperature = Temp / 8 - 256°C

### 4. 32-byte with timestamp

This format is supported for any firmware after Ver. 0.0.5

| byte        | 0    | 1    | 2      | 3      | 4     | 5     | 6-9       | 10        |
|-------------|------|------|--------|--------|-------|-------|-----------|-----------|
| Description | 0x59 | 0x59 | Dist_L | Dist_H | Amp_L | Amp_H | Timestamp | Check_sum |

Dist: cm

Amp: Signal strength indicator. Dist value is unreliable when Amp < 100 or Amp = 65535 (Overexposure)

Timestamp: Timestamp (ms) is in small-end format

### 5. ID-0 output

This format is supported for any firmware after Ver. 0.0.5

| byte        | 0    | 1   | 2    | 3      | 4      | 5     | 6     | 7-10      | 11        |
|-------------|------|-----|------|--------|--------|-------|-------|-----------|-----------|
| Description | 0x5A | Len | 0x00 | Dist_L | Dist_H | Amp_L | Amp_H | Timestamp | Check_sum |

Dist: cm

Amp: Signal strength indicator. Dist value is unreliable when Amp < 100 or Amp = 65535 (Overexposure)

Timestamp: Timestamp (ms) is in small-end format

### 6. 8-byte/cm

This format is supported for any firmware after Ver. 0.0.5

| byte        | 0      | 1      | 2     | 3     | 4-7       |
|-------------|--------|--------|-------|-------|-----------|
| Description | Dist_L | Dist_H | Amp_L | Amp_H | Timestamp |





Dist: cm

Amp: Signal strength indicator. Dist value is unreliable when Amp < 100 or Amp = 65535 (Overexposure)

Timestamp: Timestamp (ms) is in small-end format

## 7. Output with Device ID

This format is supported for any firmware after Ver. 3.0.8

| byte        | 0    | 1    | 2    | 3      | 4      | 5     | 6     | 7-10      | 11     | 12        |
|-------------|------|------|------|--------|--------|-------|-------|-----------|--------|-----------|
| Description | 0x5A | 0x0D | 0x00 | Dist_L | Dist_H | Amp_L | Amp_H | Timestamp | Dev_Id | Check_sum |

Dist: cm

Amp: Signal strength, if AMP is lower than 100, the range value is considered not reliable. Overexposure value is 65535

Timestamp: Timestamp (ms) is in little-endian format

Dev\_Id: device ID, same as the address of I2C slave device



## Appendix II Serial communication protocol

### 1. Version information ID\_GET\_VERSION=0x01

This format is supported for any firmware after Ver. 0.0.5

Downward:

| byte        | 0          | 1   | 2  | Len-1     |
|-------------|------------|-----|----|-----------|
| Description | Head(0x5A) | Len | ID | Check_sum |

Upward:

| byte        | 0          | 1   | 2  | 3~5      | Len-1     |
|-------------|------------|-----|----|----------|-----------|
| Description | Head(0x5A) | Len | ID | *Version | Check_sum |

\*Version: For instance, if the third, fourth, and fifth bytes are 112, 50, 9, then the version is 9.50.112

**Sample instruction:** [5A 04 01 00]

### 2. System software restore ID\_SOFT\_RESET=0x02

This format is supported for any firmware after Ver. 0.0.5

Downward

| byte        | 0          | 1   | 2  | Len-1     |
|-------------|------------|-----|----|-----------|
| Description | Head(0x5A) | Len | ID | Check_sum |

Upward

| byte        | 0          | 1   | 2  | 3       | Len-1     |
|-------------|------------|-----|----|---------|-----------|
| Description | Head(0x5A) | Len | ID | *Status | Check_sum |

\*Status: 0 (success), otherwise (fail)

Note: Any change without “save current setting” instruction will not be saved and will restore to original setting.

**Sample instruction:** [5A 04 02 00]

### 3. Output frequency ID\_SAMPLE\_FREQ=0x03

This format is supported for any firmware after Ver. 0.0.5

Downward

| byte        | 0          | 1   | 2  | 3~4  | Len-1     |
|-------------|------------|-----|----|------|-----------|
| Description | Head(0x5A) | Len | ID | Freq | Check_sum |
| Default     |            |     |    | 100  |           |

Freq: Working frequency if Freq > 0, and Trigger mode if Freq = 0.

Upward

| byte        | 0          | 1   | 2  | 3~4  | Len-1     |
|-------------|------------|-----|----|------|-----------|
| Description | Head(0x5A) | Len | ID | Freq | Check_sum |

Freq: The current working frequency of the LiDAR

**Sample instruction:**

10Hz [5A 06 03 0A 00 00]

250Hz [5A 06 03 FA 00 00]



#### 4. Trigger mode ID\_SAMPLE\_TRIG=0x04

This format is supported for any firmware after Ver. 0.0.5

Downward

| byte        | 0          | 1   | 2  | Len-1     |
|-------------|------------|-----|----|-----------|
| Description | Head(0x5A) | Len | ID | Check_sum |

Upward

Data frame

**Sample instruction:** [5A 04 04 00]

#### 5. Output format setting ID\_OUTPUT\_FORMAT=0x05

This format is supported for any firmware after Ver. 0.0.5

Downward

| byte        | 0          | 1   | 2  | 3      | Len-1     |
|-------------|------------|-----|----|--------|-----------|
| Description | Head(0x5A) | Len | ID | Format | Check_sum |
| Default     |            |     |    | 0x01   |           |

Format:

0x01 = 9-byte/cm

0x02 = PIX

0x06 = 9-byte/mm

0x07 = 32-byte with timestamp

0x08 = ID-0

0x09 = 8-byte/cm

0x0A = Output with device ID

Upward

| byte        | 0          | 1   | 2  | 3      | Len-1     |
|-------------|------------|-----|----|--------|-----------|
| Description | Head(0x5A) | Len | ID | Format | Check_sum |

Format: TF-Luna's current output format setting

**Example:** [5A 05 05 02 00] means PIX

#### 6. Baud rate setting ID\_BAUD\_RATE=0x06

This format is supported for any firmware after Ver. 0.0.5

Downward

| byte        | 0          | 1   | 2  | 3~6       | Len-1     |
|-------------|------------|-----|----|-----------|-----------|
| Description | Head(0x5A) | Len | ID | Baud rate | Check_sum |
| Default     |            |     |    | 115200    |           |

Upward

| byte        | 0          | 1   | 2  | 3~6       | Len-1     |
|-------------|------------|-----|----|-----------|-----------|
| Description | Head(0x5A) | Len | ID | Baud rate | Check_sum |

Baud rate: TF-Luna's current baud rate.

Note: Only baud rate in [9600, 921600] are supported.

**Example:**

9600 [5A 08 06 80 25 00 00 00]

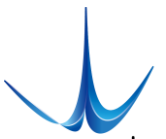

19200 [5A 08 06 00 4B 00 00 00]  
 38400 [5A 08 06 00 96 00 00 00]  
 57600 [5A 08 06 00 E1 00 00 00]  
 115200 [5A 08 06 00 C2 01 00 00]  
 230400 [5A 08 06 00 84 03 00 00]  
 460800 [5A 08 06 00 08 07 00 00]  
 921600 [5A 08 06 00 10 0E 00 00]

## 7. Enable/disable output ID\_OUTPUT\_EN=0x07

This format is supported for any firmware after Ver. 0.0.5

Downward

| byte        | 0          | 1   | 2  | 3      | Len-1     |
|-------------|------------|-----|----|--------|-----------|
| Description | Head(0x5A) | Len | ID | Enable | Check_sum |
| Default     |            |     |    | 1      |           |

Enable: 0 to disable, 1 to enable.

Upward

| byte        | 0          | 1   | 2  | 3      | Len-1     |
|-------------|------------|-----|----|--------|-----------|
| Description | Head(0x5A) | Len | ID | Enable | Check_sum |

### Example:

Enable output [5A 05 07 01 00]

Disable output [5A 05 07 00 00]

## 8. Enable/disable checksum comparison ID\_FRAME\_CHECKSUM\_EN=0x08

This format is supported for any firmware after Ver. 0.0.5

Downward

| byte        | 0          | 1   | 2  | 3      | Len-1     |
|-------------|------------|-----|----|--------|-----------|
| Description | Head(0x5A) | Len | ID | Enable | Check_sum |
| Default     |            |     |    | 0      |           |

Enable: 0 to disable, 1 to enable.

Note: Even if the Downward data checksum comparison is disabled, the valid checksum is still included in the upward data frame

Upward

| byte        | 0          | 1   | 2  | 3      | Len-1     |
|-------------|------------|-----|----|--------|-----------|
| Description | Head(0x5A) | Len | ID | Enable | Check_sum |

### Example:

Enable checksum comparison [5A 05 08 01 00]

Disable checksum comparison [5A 05 08 00 67]

## 9. I2C slave machine address configuration ID\_I2C\_SLAVE\_ADDR=0x0B

This format is supported for any firmware after Ver. 1.0.0

Downward

| byte        | 0          | 1   | 2  | 3              | Len-1     |
|-------------|------------|-----|----|----------------|-----------|
| Description | Head(0x5A) | Len | ID | I2c_slave_addr | Check_sum |

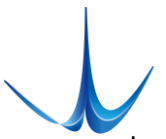

|         |  |  |  |      |  |
|---------|--|--|--|------|--|
| Default |  |  |  | 0x10 |  |
|---------|--|--|--|------|--|

I2c\_slave\_addr: range [0x08, 0x77]

Upward

|             |            |     |    |                |           |
|-------------|------------|-----|----|----------------|-----------|
| byte        | 0          | 1   | 2  | 3              | Len-1     |
| Description | Head(0x5A) | Len | ID | I2c_slave_addr | Check_sum |

**Example:**

Change to 0x20 [5A 05 0B 20 00]

## 10. Restore default setting ID\_RESTORE\_DEFAULT=0x10

This format is supported for any firmware after Ver. 0.0.5

Downward

|             |            |     |    |           |
|-------------|------------|-----|----|-----------|
| byte        | 0          | 1   | 2  | Len-1     |
| Description | Head(0x5A) | Len | ID | Check_sum |

Upward

|             |            |     |    |        |           |
|-------------|------------|-----|----|--------|-----------|
| byte        | 0          | 1   | 2  | 3      | Len-1     |
| Description | Head(0x5A) | Len | ID | Status | Check_sum |

Status: 0 for success, otherwise for errors

**Example:**

Restore default setting [5A 04 10 00]

## 11. Save current setting ID\_SAVE\_SETTINGS=0x11

This format is supported for any firmware after Ver. 0.0.5

Downward

|             |            |     |    |           |
|-------------|------------|-----|----|-----------|
| byte        | 0          | 1   | 2  | Len-1     |
| Description | Head(0x5A) | Len | ID | Check_sum |

Upward

|             |            |     |    |        |           |
|-------------|------------|-----|----|--------|-----------|
| byte        | 0          | 1   | 2  | 3      | Len-1     |
| Description | Head(0x5A) | Len | ID | Status | Check_sum |

Status: 0 for success, otherwise for errors

**Example:** [5A 04 11 00]

## 12. Output product bar code ID\_READ\_MANU\_BIN=0x12

This format is supported for any firmware after Ver. 0.0.5

Downward

|             |            |     |    |           |
|-------------|------------|-----|----|-----------|
| byte        | 0          | 1   | 2  | Len-1     |
| Description | Head(0x5A) | Len | ID | Check_sum |

Upward

|             |            |     |    |      |           |
|-------------|------------|-----|----|------|-----------|
| byte        | 0          | 1   | 2  | 3-16 | Len-1     |
| Description | Head(0x5A) | Len | ID | Bin  | Check_sum |

Bin: 14 byte product bar code

**Example:**

Send [5A 04 12 00]



Receive: U0900018010001, then the code is from the third byte to the sixteenth:

0x55 0x30 0x39 0x30 0x30 0x30 0x31 0x38 0x30 0x31 0x30 0x30 0x30 0x31

### 13. Get full-length version number ID\_GET\_FULL\_VERSION=0x14

This format is supported for any firmware after Ver. 0.0.5

Downward

| byte        | 0          | 1   | 2  | Len-1     |
|-------------|------------|-----|----|-----------|
| Description | Head(0x5A) | Len | ID | Check_sum |

Upward

| byte        | 0           | 1   | 2  | 3-10 | 11 | 12-19  | 20 | 21-22             | 23 | 24-25             | 26 | 27-28                | Len-1     |
|-------------|-------------|-----|----|------|----|--------|----|-------------------|----|-------------------|----|----------------------|-----------|
| Description | Head (0x5A) | Len | ID | Name | '  | Branch | '  | Major version No. | '  | Minor version No. | '  | Revision version No. | Check_sum |

**Example:** [5A 04 14 00]

### 14. Amp threshold setting ID\_AMP\_THRESHOLD=0x22

This format is supported for any firmware after Ver. 0.0.5

Downward

| byte        | 0          | 1   | 2  | 3             | 4-5        | Len-1     |
|-------------|------------|-----|----|---------------|------------|-----------|
| Description | Head(0x5A) | Len | ID | Amp_Threshold | Dummy_Dist | Check_sum |
| Default     |            |     |    | 10            | 0          |           |

Amp\_Threshold: When Amp < Amp\_Threshold \* 10, then output Dummy\_Dist instead of the result of calculation

Dummy\_Dist: The output distance when Amp is too low.

Upward

| byte        | 0          | 1   | 2  | 3             | 4-5        | Len-1     |
|-------------|------------|-----|----|---------------|------------|-----------|
| Description | Head(0x5A) | Len | ID | Amp_Threshold | Dummy_Dist | Check_sum |

**Example:**

To output 500 cm when Amp < 300 [5A 07 22 1E F4 01 00]

### 15. Switch between Single Frequency and Dual Frequency ID\_DEALIAS\_EN=0x29

This format is supported for any firmware after Ver. 0.0.5

Downward

| byte        | 0          | 1   | 2  | 3      | Len-1     |
|-------------|------------|-----|----|--------|-----------|
| Description | Head(0x5A) | Len | ID | Enable | Check_sum |
| Default     |            |     |    | 1      |           |

Enable: 1 (Dual Frequency Mode) 0 (Single Frequency Mode)

Upward

| byte        | 0          | 1   | 2  | 3      | Len-1     |
|-------------|------------|-----|----|--------|-----------|
| Description | Head(0x5A) | Len | ID | Enable | Check_sum |

**Example:**

Dual Frequency Mode [5A 05 29 01 00]

Single Frequency Mode [5A 05 29 00 00]

## 16. Timestamp synchronization ID\_TIMESTAMP\_SYNC =0x31

This format is supported for any firmware after Ver. 0.0.5

Downward

| byte        | 0          | 1   | 2  | 3-6 | Len-1     |
|-------------|------------|-----|----|-----|-----------|
| Description | Head(0x5A) | Len | ID | Std | Check_sum |
| Default     |            |     |    | 0   |           |

Std: The current std timestamp specified

**Example:**

To set timestamp to 1000ms [5A 08 31 E8 03 00 00 00]

## 17. Enable/disable Power saving mode (ECO) ID\_LOW\_CONSUMPTION=0x35

This format is supported for any firmware after Ver. 0.0.5

Downward

| byte        | 0          | 1   | 2  | 3-4         | Len-1     |
|-------------|------------|-----|----|-------------|-----------|
| Description | Head(0x5A) | Len | ID | Sample_rate | Check_sum |
| Default     |            |     |    | 0           |           |

Sample\_rate: Work frequency if Sample\_rate is positive (0 to disable power saving)

Upward

| byte        | 0          | 1   | 2  | 3-4         | Len-1     |
|-------------|------------|-----|----|-------------|-----------|
| Description | Head(0x5A) | Len | ID | Sample_rate | Check_sum |

**Example:**

Enable power saving mode and measure at 10Hz frequency [5A 06 35 0A 00 00]

## 18. Filter Setup ID\_FILTER\_BIT\_MAP=0x39

This format is supported for any firmware after Ver. 0.0.5

Downward

| byte        | 0          | 1   | 2  | 3              | Len-1     |
|-------------|------------|-----|----|----------------|-----------|
| Description | Head(0x5A) | Len | ID | Filter_bit_map | Check_sum |
| Default     |            |     |    | 0x03           |           |

Filter\_bit\_map: Filter setup: 0 to disable, 1 to enable.

Bit0 – Kalman Filter

Bit1 – Median Filter

Upward

| byte        | 0          | 1   | 2  | 3              | Len-1     |
|-------------|------------|-----|----|----------------|-----------|
| Description | Head(0x5A) | Len | ID | Filter_bit_map | Check_sum |

**Example:**



Filter off [5A 05 39 00 00]

Filter on [5A 05 39 03 00]

## 19. Distance limit setting ID\_DIST\_LIMIT=0x3A

This format is supported for any firmware after Ver. 0.0.5

Downward

| byte        | 0          | 1   | 2  | 3-4      | 5-6      | 7       | Len-1     |
|-------------|------------|-----|----|----------|----------|---------|-----------|
| Description | Head(0x5A) | Len | ID | Dist_min | Dist_max | Silence | Check_sum |
| Default     |            |     |    | 0        | 900      | 0       |           |

Dist\_min: minimum distance output in centimeters.

Dist\_max: maximum distance output in centimeters.

Silence: No output when the distance is out of range if silence = 1. Output limit when out of range if silence = 0

Upward

| byte        | 0          | 1   | 2  | 3-4      | 5-6      | 7       | Len-1     |
|-------------|------------|-----|----|----------|----------|---------|-----------|
| Description | Head(0x5A) | Len | ID | Dist_min | Dist_max | Silence | Check_sum |

### Example:

Output limit when out of range with the minimum set to be 20cm and the maximum set to be 500cm

[5A 09 3A 14 00 F4 01 00 00]

## 20. Enable/disable on-off mode ID\_ON\_OFF\_MODE=0x3B

This format is supported for any firmware after Ver. 1.0.0

Downward

| byte        | 0          | 1   | 2  | 3    | 4-5  | 6-7  | 8-9    | 10-11  | Len-1     |
|-------------|------------|-----|----|------|------|------|--------|--------|-----------|
| Description | Head(0x5A) | Len | ID | Mode | Dist | Zone | Delay1 | Delay2 | Check_sum |
| Default     |            |     |    | 0    | 0    | 0    | 0      | 0      |           |

Mode: 0 (Normal output), 1 (On-off mode with high level output when closer), 2 (On-off mode with low level output when closer)

Dist: critical dist value (the closer one) in centimeters.

Zone: Zone size in centimeters

Delay1: Delay time 1 in millisecond. Pin 6 switch level only if the distance detected is less than Dist and the situation last for Delay1 long.

Delay2: Delay time 2 in millisecond. Pin 6 switch level only if the distance detected is more than Dist + Zone and the situation last for Delay2 long.

### Example:

Enable on-off mode with high level output when closer, and set Dist = 200cm, Zone=10cm, Delay1 = Delay2 = 1000ms:

[5A 0D 3B 01 CB 00 0A 00 E8 03 E8 03 00]

## 21. Read config by id ID\_GET\_CONFIG\_PARA=0x3F

This format is supported for any firmware after Ver. 0.0.5





Downward

| byte        | 0          | 1   | 2  | 3  | Len-1     |
|-------------|------------|-----|----|----|-----------|
| Description | Head(0x5A) | Len | ID | Id | Check_sum |

Id: The same as we mentioned above.

Upward: The same format of relevant Id.

**Example:**

Read output frequency [5A 05 3F 03 00]

## 22. Ultra-low Power Mode ID\_ULTRA\_LOW\_POWER\_MODE=0x58

This format is supported for any firmware after Ver. 3.0.7

Downward

| byte        | 0          | 1   | 2  | 3      | Len-1     |
|-------------|------------|-----|----|--------|-----------|
| Description | Head(0x5A) | Len | ID | Enable | Check_sum |

Enable: 0 to disable, 1 to enable.

Upward

| byte        | 0          | 1   | 2  | 3      | Len-1     |
|-------------|------------|-----|----|--------|-----------|
| Description | Head(0x5A) | Len | ID | Enable | Check_sum |

**Example:**

Turn on Ultra-low Power Mode [5A 05 58 01 00]

Turn off Ultra-low Power Mode [5A 05 58 00 00]. Since there is a time period in an Ultra-low Power Mode awakening phase, the turn-off command should be sent multiple times, e.g. [5A 05 58 00 00 5A 05 58 00 00 5A 05 58 00 00 5A 05 58 00 00 5A 05 58 00 00]

## 23. Frequency Calibration ID\_FREQ\_CNT\_CALIB=0x59

This format is supported for any firmware after Ver. 3.0.7

Downward

| byte        | 0          | 1   | 2  | 3   | Len-1     |
|-------------|------------|-----|----|-----|-----------|
| Description | Head(0x5A) | Len | ID | Cmd | Check_sum |

Cmd: 1 (Execute frequency calibration, which takes about two seconds), 2 (Read frequency calibration parameters)

Upward

| byte        | 0          | 1   | 2  | 3-4            | Len-1     |
|-------------|------------|-----|----|----------------|-----------|
| Description | Head(0x5A) | Len | ID | Calib_freq_cnt | Check_sum |

Calib\_freq\_cnt: For frequency calibration parameters, a non-zero value indicates the completion of calibration

**Example:**

Execute frequency calibration [5A 05 59 01 00]

Read frequency calibration parameters [5A 05 59 02 00]



## Appendix III I2C register table

| Address   | R/W | Name             | Initial Value | Description   |
|-----------|-----|------------------|---------------|---|
| 0x00      | R   | DIST_LOW         | --            | cm  |
| 0x01      | R   | DIST_HIGH        | --            |   |
| 0x02      | R   | AMP_LOW          | --            |   |
| 0x03      | R   | AMP_HIGH         | --            |   |
| 0x04      | R   | TEMP_LOW         | --            | Unit: 0.01 Celsius  |
| 0x05      | R   | TEMP_HIGH        | --            |   |
| 0x06      | R   | TICK_LOW         | --            | Timestamp   |
| 0x07      | R   | TICK_HIGH        | --            |   |
| 0x08      | R   | ERROR_LOW        | --            |   |
| 0x09      | R   | ERROR_HIGH       | --            |   |
| 0x0A      | R   | VERSION_REVISION | --            |   |
| 0x0B      | R   | VERSION_MINOR    | --            |   |
| 0x0C      | R   | VERSION_MAJOR    | --            |   |
| 0x0D-0x0F |     |                  | --            | Hold  |
| 0x10-0x1D | R   | SN               | --            | Production code in 14 bytes ASCII code (0x10 is the first byte) |
| 0x1E      |     |                  | --            | Hold  |
| 0x1F      | W   | ULTRA_LOW_POWER  | --            | 0x00: Normal<br>0x01: Ultra-low power mode                      |
| 0x20      | W   | SAVE             | --            | Write 0x01 to save current setting                              |
| 0x21      | W   | SHUTDOWN/REBOOT  | --            | Write 0x02 to reboot  |
| 0x22      | W/R | SLAVE_ADDR       | 0x10          | Range: [0x08, 0x77]   |





|           |     |                          |      |   |
|-----------|-----|--------------------------|------|---|
| 0x23      | W/R | MODE                     | 0x00 | 0x00: Continuous ranging mode<br>0x01: Trigger mode |
| 0x24      | W   | TRIG_ONE_SHOT            | --   | 0x01: Trigger once (only on trigger mode)           |
| 0x25      | W/R | ENABLE                   | 0x01 | 0x00: Turn off LiDAR<br>0x01: Turn on LiDAR         |
| 0x26      | W/R | FPS_LOW                  | 0x64 |   |
| 0x27      | W/R | FPS_HIGH                 | 0x00 |   |
| 0x28      | W/R | LOW_POWER                | 0x00 | 0x00: Normal<br>0x01: Power saving mode             |
| 0x29      | W   | RESTORE_FACTORY_DEFAULTS | --   | Write 0x01 to restore factory default settings      |
| 0x2A      | W/R | AMP_THR_LOW              | 0x64 | Amp threshold value                                 |
| 0x2B      | W/R | AMP_THR_HIGH             | 0x00 |   |
| 0x2C      | W/R | DUMMY_DIST_LOW           | 0x00 | Dummy dist value                                    |
| 0x2D      | W/R | DUMMY_DIST_HIGH          | 0x00 |   |
| 0x2E      | W/R | MIN_DIST_LOW             | 0x00 | Minimum dist in mm, but not working on DUMMY_DIST   |
| 0x2F      | W/R | MIN_DIST_HIGH            | 0x00 |   |
| 0x30      | W/R | MAX_DIST_LOW             | 0x20 | Maximum dist in mm, but not working on DUMMY_DIST   |
| 0x31      | W/R | MAX_DIST_HIGH            | 0x03 |   |
| 0x32-0x3B |     |                          | --   | Hold  |
| 0x3C-0x3F | R   | SIGNATURE                | --   | 'L' 'U' 'N' 'A'                                     |

