

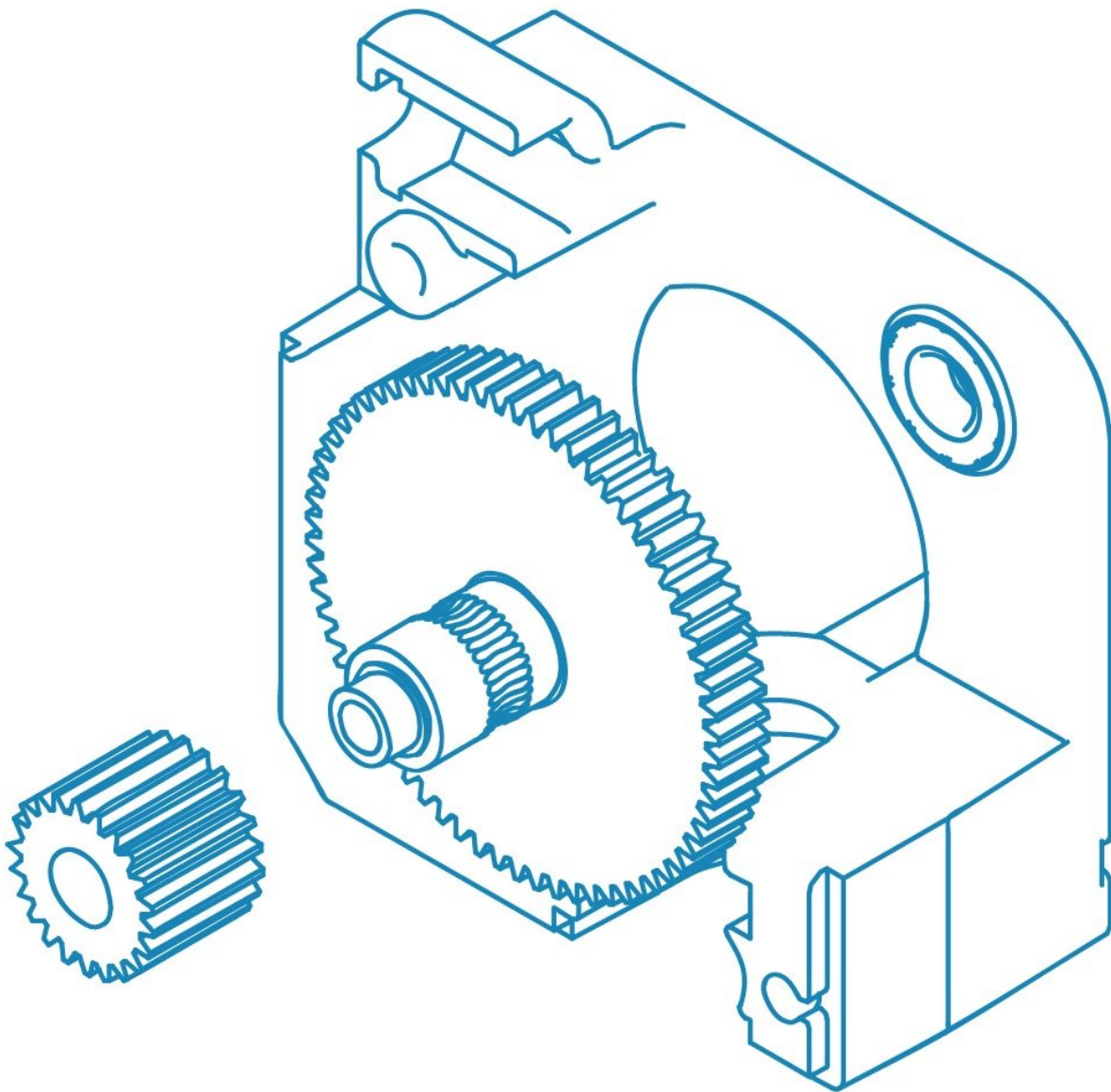

1.75mm Bowden Titan Assembly

Learn how to assemble your Titan for 1.75mm filament in a bowden configuration.

Written By: Gabe S.



 **TOOLS:**

- [Hex Wrench, 1.5mm](#) (1)
- [Hex Wrench, 2.5mm](#) (1)
- [Hex Wrench 3mm](#) (1)
- [Craft Knife](#) (1)

Any sharp knife will do (scissors as last resort)

 **PARTS:**

- [Titan Extruder Body](#) (1)
- [Steel Pinion Gear](#) (1)
- [Delrin Gear with Filament Drive Shaft](#) (1)
- [M3 Grub Screw](#) (1)
- [M3x10 Socket Dome Screw](#) (1)
- [PTFE Tubing](#) (2)
- [Titan Filament Guide](#) (1)

1.75mm

Labeled either "1.75L" or "1.75R"

- [M3x30 Screws](#) (1)
- [Titan Idler Lever](#) (1)
- [M4 Thumbscrew](#) (1)
- [Idler Spring](#) (1)
- [M4x10 Button Head Screw](#) (1)
- [M3 Nut](#) (1)
- [Titan Lid](#) (1)
- [M3x25 Screw](#) (1)
- [Compact but powerful motor \(optional extra\)](#) (1)

Step 1 — Prep: Mounting Your Titan



- Before beginning your build, make sure that you have an appropriate mount for your extruder. If you have a commonly upgraded printer (Ultimaker 2, Taz 5/6, Prusa i3, etc) you'll likely be able to find 3D models of well designed Titan mounts on your favourite 3D model sharing site.
 - When installing the Titan, you must have something to separate the motor from the extruder body by 2 mm. Typically, a piece of your mounting bracket will attach here and provide this space (for reference take a look at our [Prusa Mounting Bracket](#)). Having a separation of more than 2mm will mean you need longer screws to hold the assembly together.
- i** Please note that there may be extra bolts in the titan fixing kit bag that will be unused.

Step 2 — Gather Titan Body

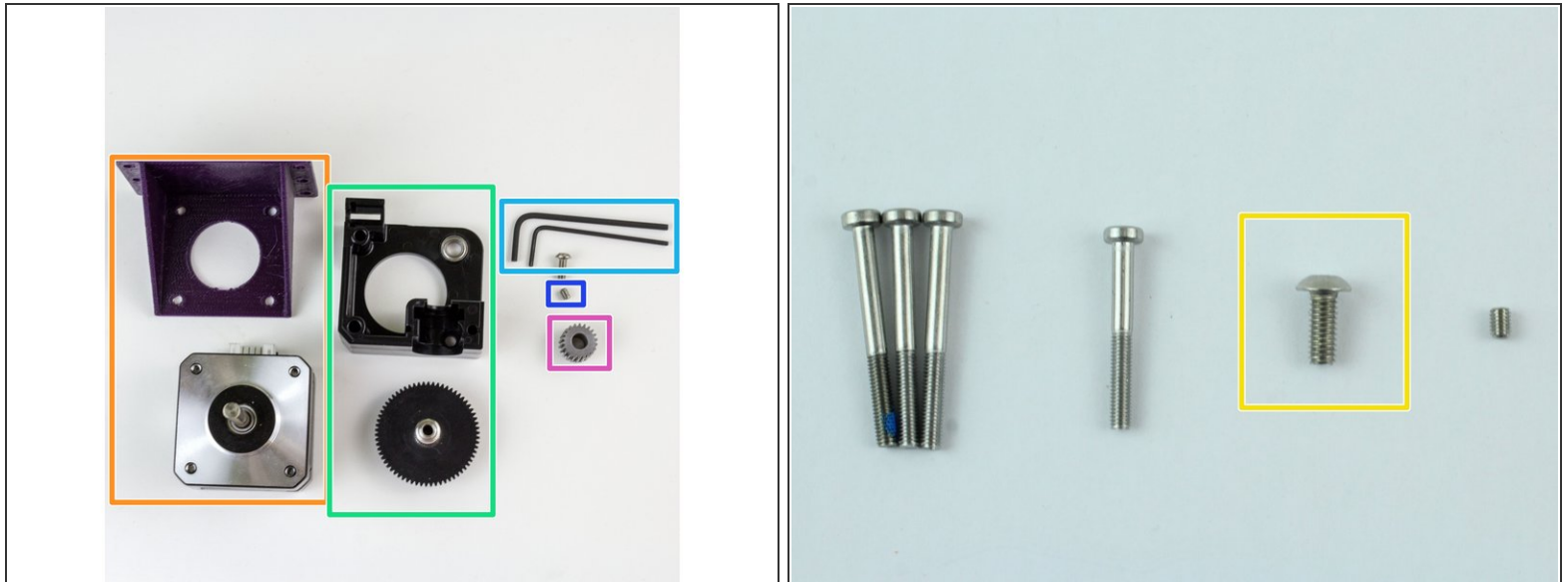

- Gather
 - The motor you'll be using + mounting bracket
 - Extruder Body + Large Gear
 - M3x8mm Screw
 - M3 Grub Screw
 - Pinion Gear
 - The Smallest, 1.5mm Hex Wrench, and Mid-sized, 2.5mm Hex Wrench

Step 3 — Attach Pinion Gear to Motor

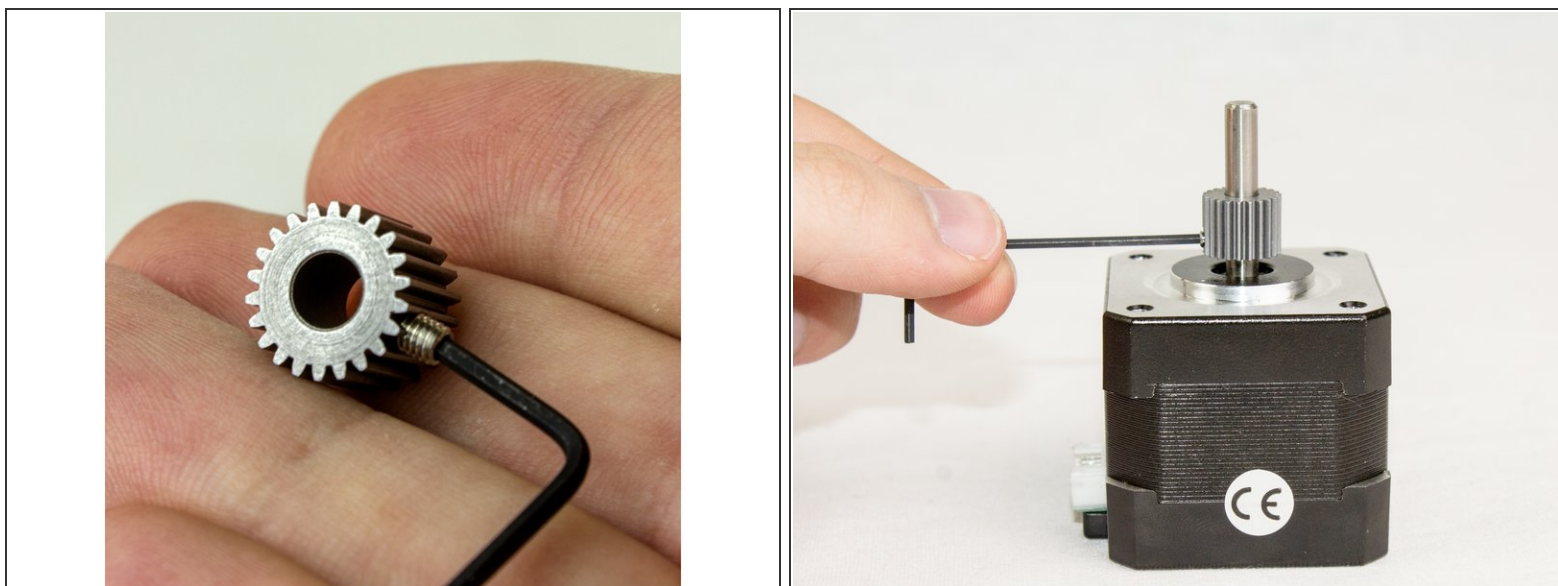

- Thread the M3 grub screw into the pinion gear slightly so you don't lose it
 - Slip the pinion gear onto the motor shaft with the grub screw facing down, towards the motor.
 - Slide it about 3/4 of the way down the shaft and tighten the screw.
- i** The compact but powerful motor has a fully round shaft. - some of the older kits used the slimline motor which has a flat on the shaft.
- i** As of March 2019 the compact but powerful now has a flat ground on the shaft.

Step 4

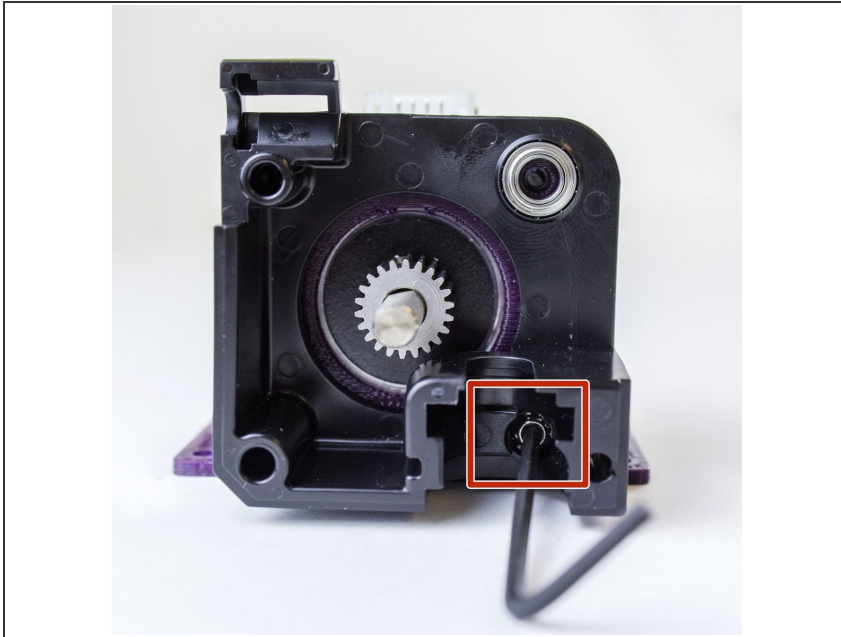

- Take your M3 screw that you picked out before and slip it through the hole extruder body in the groove mount (lower leftmost screw hole).
- Slip the screw through your mounting bracket (including spacer if you're using one) and screw it into your motor.

Step 5 — Place the Hobb Gear

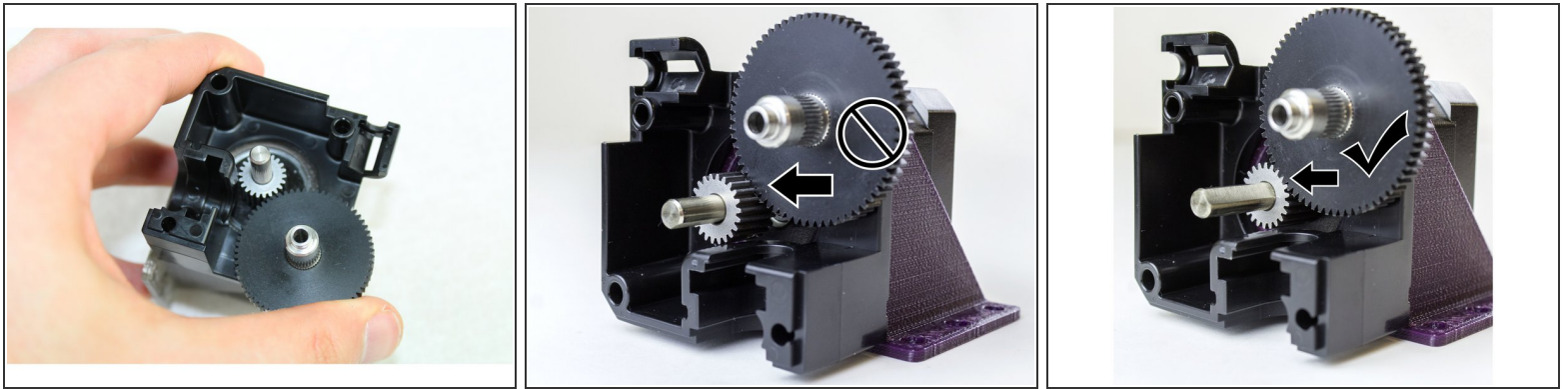

- Slot in the Hobb gear (attached to the other gear)
 - You need to have the top of the pinion gear flush with the top of the Hobb gear.
 - If it isn't—and it likely won't be on the first try—loosen the grub screw and adjust the positioning of the pinion gear on the motor's shaft. You may need to unscrew the extruder body to get at the grub screw.
 - When you think you've got it, try pressing down on the Hobb gear lightly to see how it will fare when the whole extruder is screwed in and make sure it's still flush.
- ⚠ If the pinion gear is mounted too high you will risk pinching the idler arm against the heat sink which will cause excessive friction.
- ⚠ If the pinion gear is mounted too low it will not make full contact with the Hobb gear which risks causing uneven wear.

Step 6 — Gather Bowden Parts

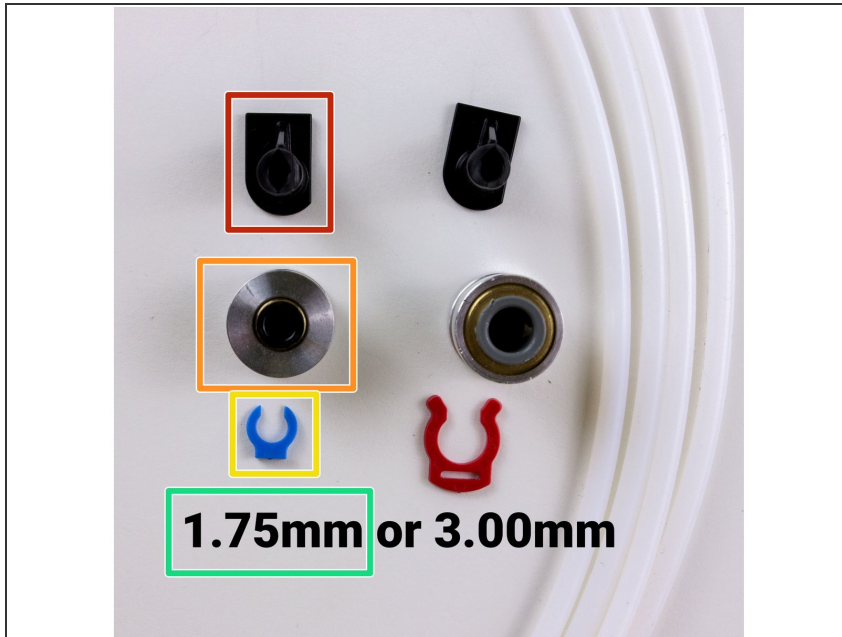

- Gather:
 - 1.75mm Filament Guide (marked "L" or "R" depending on mirrored or non-mirrored setup.)
 - 1.75mm Bowden Adaptor (metal)
 - 1.75mm Collet Clip
- PTFE Tubing

Step 7 — Slide in Filament Guide Adaptor

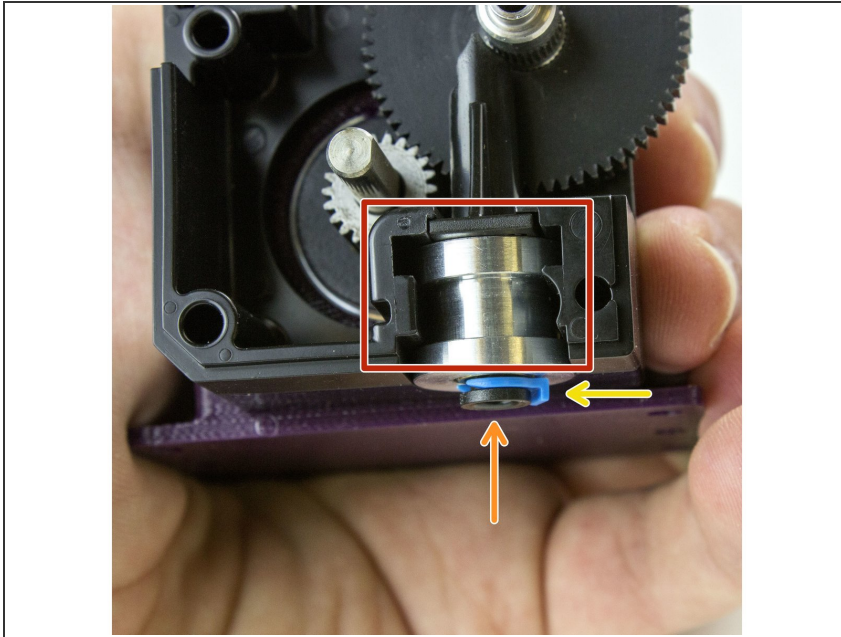

- Slide in the filament guide (round side down) and bowden adaptor into the bottom groove where you screwed the extruder body to your motor.
- Press the black collet into the bowden adaptor.
- Clip on the collet clip.
- ⓘ It's ok if the adaptor is not completely snug.

Step 8 — Slide in PTFE Tubing

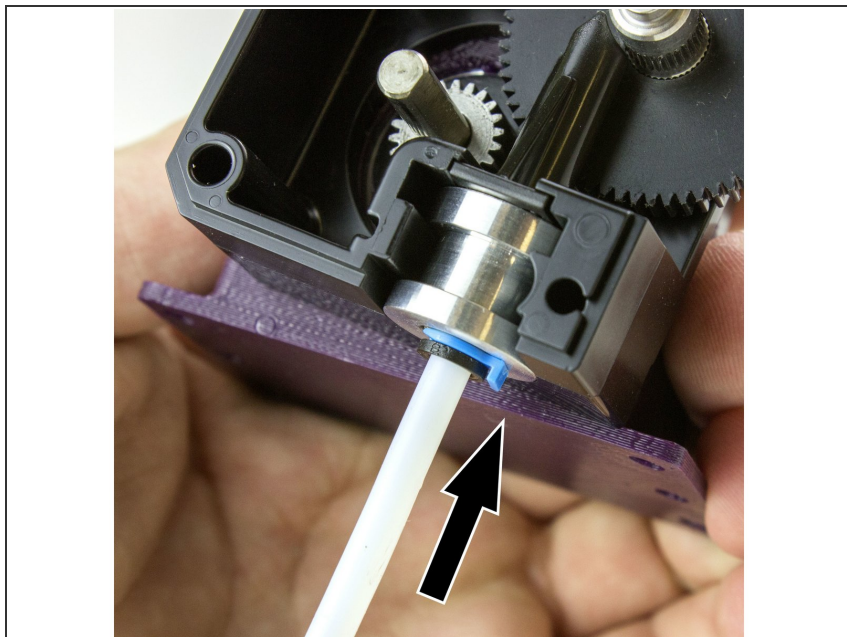

- Slide in your PTFE tubing until it's snug against the filament guide. This is the tubing that will eventually go into your HotEnd, so probably longer than the little bit that comes with the Titan kit.
- The collet clip should reduce the tube's wiggle once it's pushed in all the way.
- For 1.75mm filament, the bowden tubing should push *into* the filament guide.
- For the next steps, images will show a V6 in the place of the Bowden adaptor. This does not affect the rest of the build.

Step 9 — Gather Idler

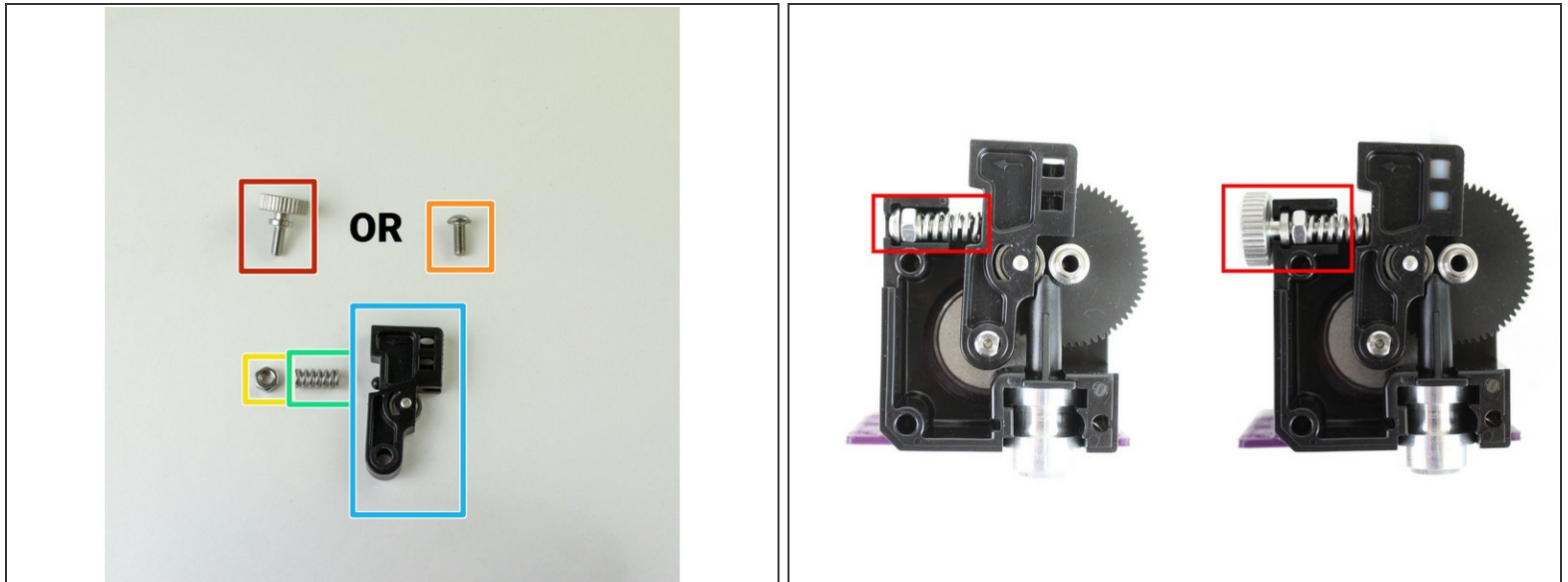

- Gather:

- M4 Thumbscrew
- **OR** M4 Button Head Screw
- M4 Nut
- Spring
- Idler Lever

i The only difference between the thumbscrew and the button head one is ease of use vs. space. If you can, we suggest using the thumbscrew.

Step 10 — Prep Idler



- Screw the M4 nut all the way onto the M4 Screw or Thumbscrew.
- Push the spring over the threaded part of the screw. The nut will eventually let you adjust the tension on your extruder by travelling down the screw and compressing the spring.
- Position the other end of the spring on the little bump on the idler lever.

Step 11 — Assemble Idler

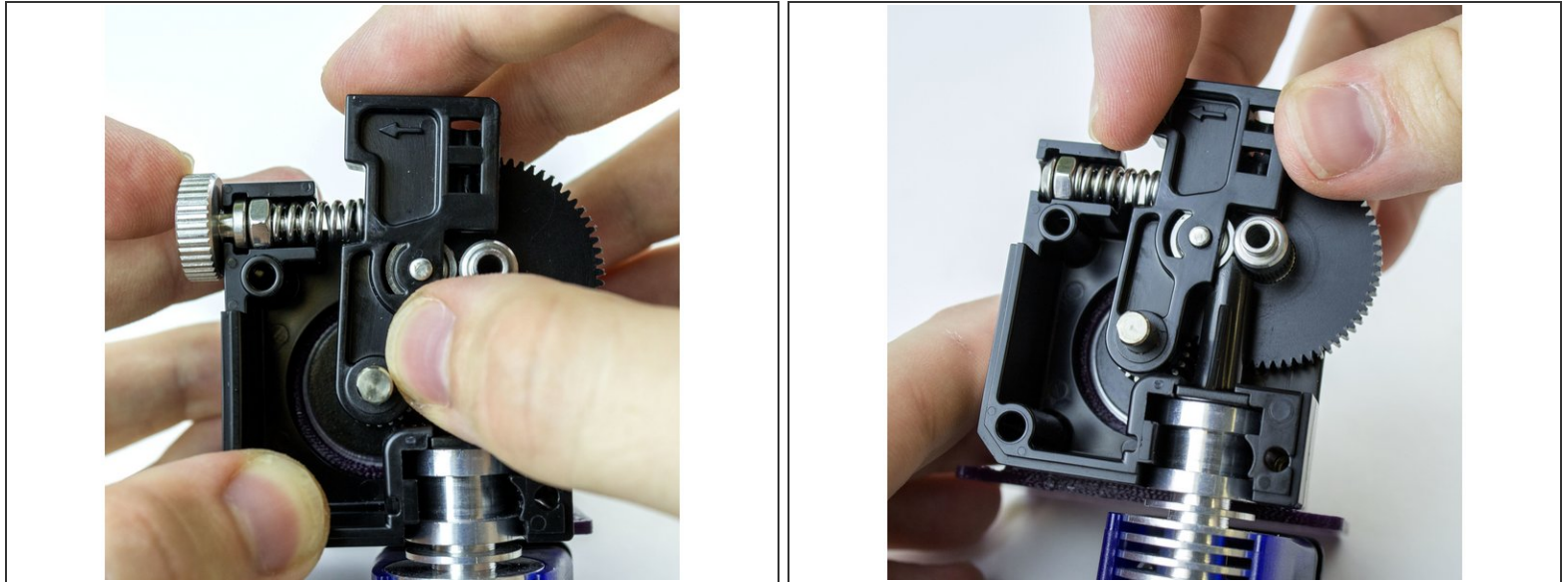

- Drop this assembly into the extruder body.
- The screw will slot into the nut-channel in the extruder body, and the idler arm will slip onto the motor shaft.
- ⓘ It is normal that the shaft sticks out slightly from the lever.
- Make sure that the nut slots into the channel fully and that the idler arm is pressed all the way onto the motor shaft.
- ⓘ Your assembly may look like either photo above, depending on whether you're using the thumbscrew or the dome screw.
- ⚠ Do not compress the spring without the Titan lid on!!! It *will* go flying out and you *will* lose it. And it *could* hit someone in the face.

Step 12 — Gather Lid Parts

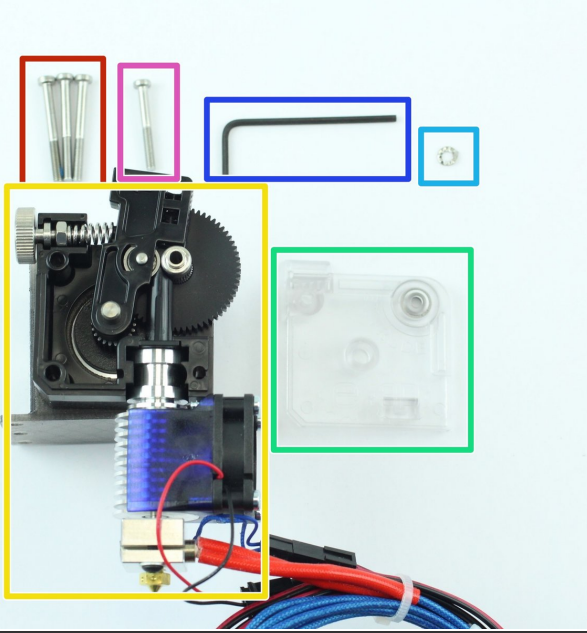

- Gather:
 - M3x30 Screws
 - Extruder Assembly
 - Titan Lid
 - Shake-proof washer
 - M3x25 Screw (the shortest M3 Screw)
 - The mid-sized 2.5mm Hex Wrench.

Step 13 — Assemble Lid

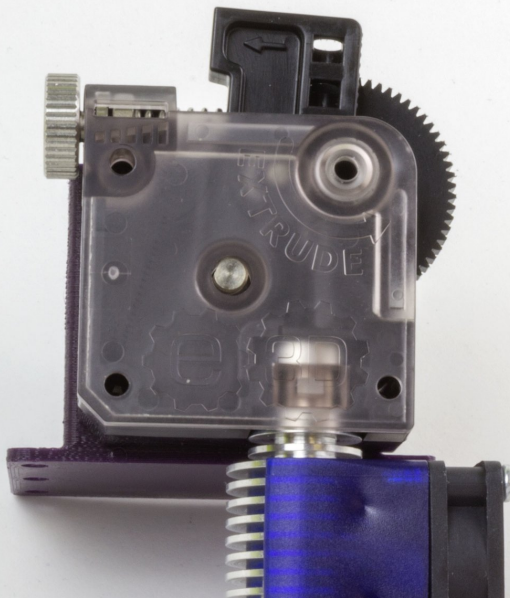

- Press on the lid to your extruder. It should be flush with all the sides of the body.

Step 14 — Screw in Lid 1

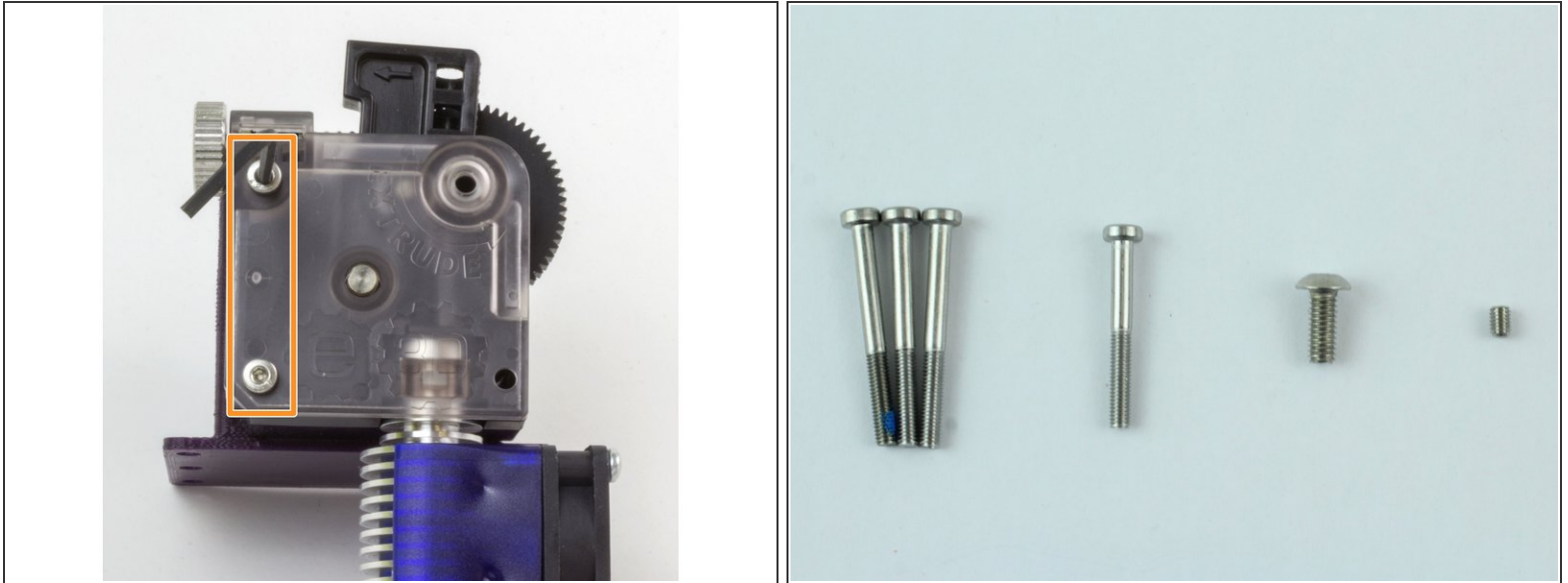

- Screw the two longer M3 screws that don't have blue patch lock on them into the left two holes on the lid.
- i** Because the extruder is only attached to the motor by one screw at the moment, you may need to wiggle it a little to get them to thread into the motor.

Step 15 — Screw in Lid 2

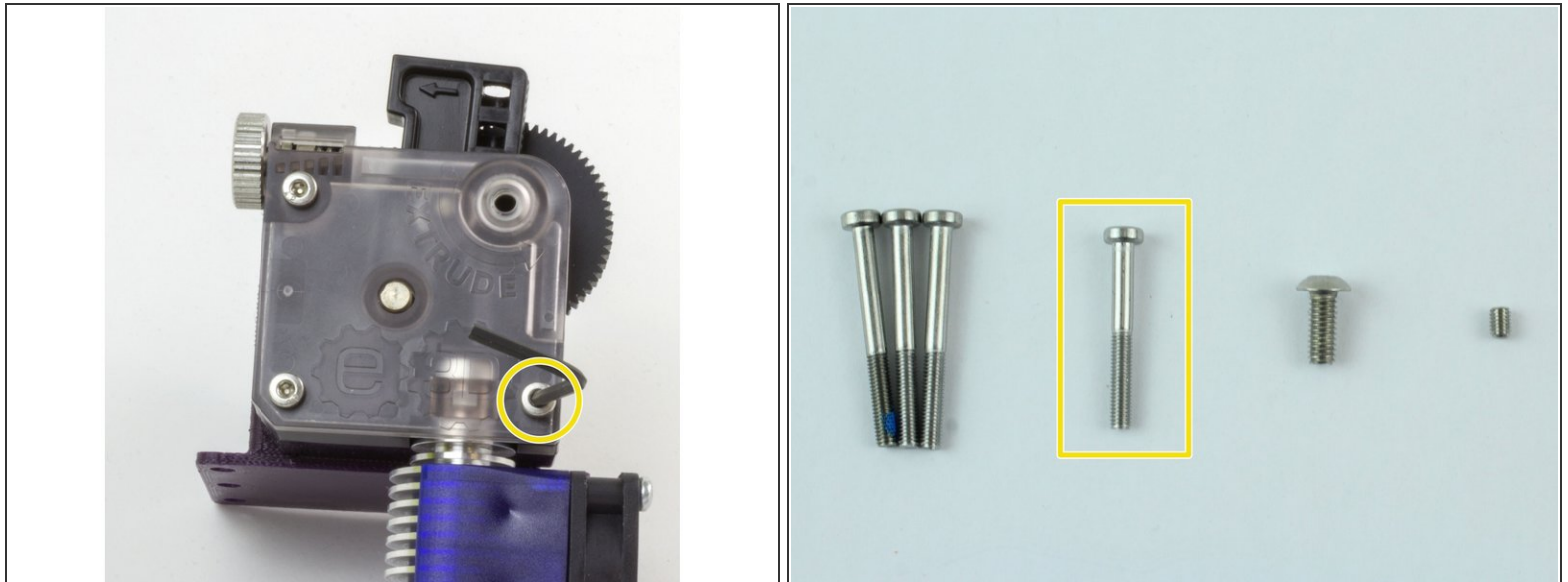

- Screw the second longest screw into the right hand corner of the lid.
- ⓘ This screw goes into the brass insert on the back of the extruder body, not your motor. It just holds the hotend in place.

Step 16 — Screw in Lid 3

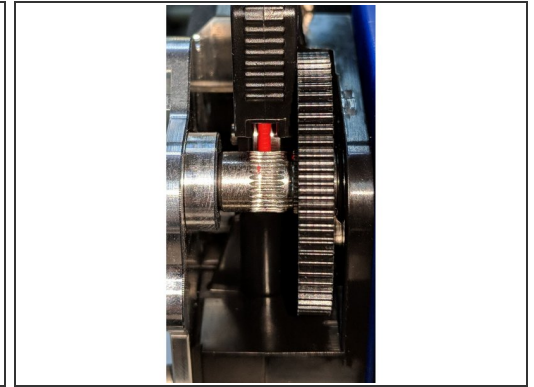

- Slip the shake-proof washer onto the screw with the blue patch lock on it.

⚠ WARNING - this screw goes through the bearings and so when it is tightened it creates an axial load on the bearings, if this screws is overtightened even once it may cause permanent damage to your bearings which will result in bearing failure -PROCEED WITH CAUTION.

- Screw in this screw until it is finger tight and no more.
- ⓘ The shake-proof washer will prevent this screw from coming loose.
- ⓘ There may be some slight visual misalignment of the idler and teeth, this is due to an inconsequential machining error of the filament drive gear. The toothed portion of the shaft is wide enough to accommodate this minor misalignment with no effect on how the teeth engage the filament.

Step 17 — Gear Alignment Check

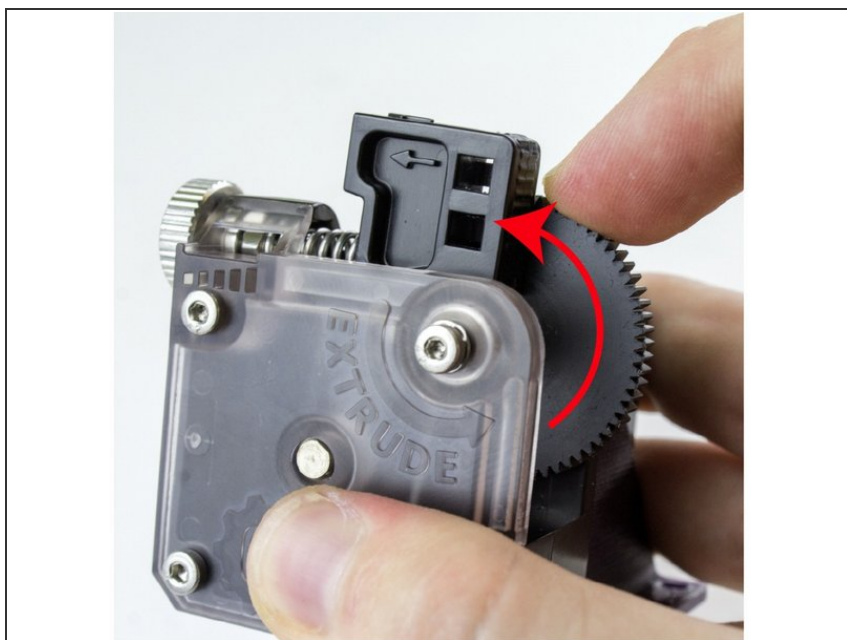

- Try to rotate the large acetal gear to see if it moves smoothly.
- If it is hard to rotate, check the position of the steel pinion gear, it may be too far forward. Adjust it so that it is flush with the front face of the acetal gear and try again.
- If this does not solve the issue, then the screw with the shake-proof washer on it may have been overtightened. If loosening this screw allows the acetal gear to run smoothly then the screw has been overtightened and permanent damage may have been caused to the bearings; seek replacement bearings if this is the case.

Step 18 — Check for Backlash

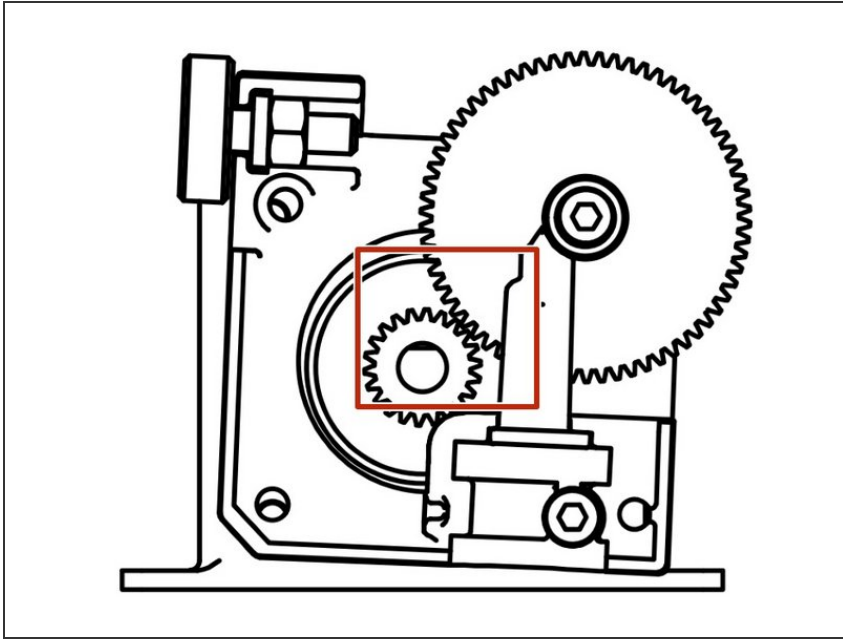

- If the large gear exhibits “backlash” (there's play between the large acetal gear and the metal one on the drive shaft), loosen all screws on the lid and rotate the body such that the gears fully mesh.
- Re-tighten the screws as described in the previous steps.

Step 19 — PTFE Idler

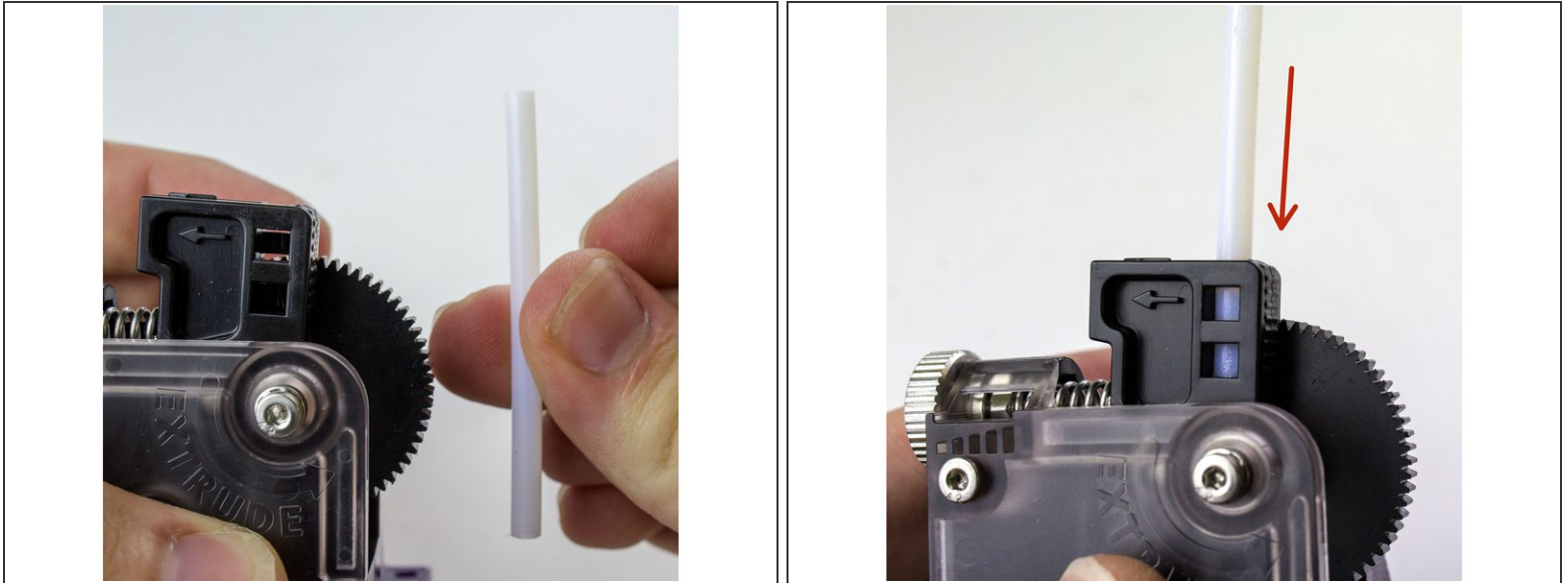

- **If you're printing 1.75mm filament**, you can guide it a little better by putting a length of PTFE tubing in the top of the idler lever
- Press the tubing into the lever.
- ⓘ It may be a very tight fit. Try inserting the PTFE with a slight twisting action, if that doesn't work you can file down the tube slightly.

Step 20 — Firmware Configuration



- You're done with the mechanical assembly! All that's left is to calibrate your new extruder by updating your firmware and EEPROM. Click on one of the links below to start working on your firmware.
 - [Marlin](#)
 - [Repetier](#)
 - [Smoothieware](#)
 - [RepRap Firmware](#)